

Firefighter Training

S-130



NFES 2370

Student Workbook
DECEMBER, 2003

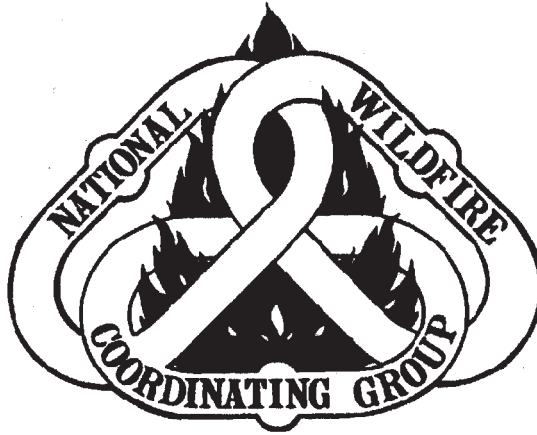

CERTIFICATION STATEMENT

on behalf of the

NATIONAL WILDFIRE COORDINATING GROUP

The following training material attains the standards prescribed for courses developed under the interagency curriculum established and coordinated by the National Wildfire Coordinating Group. The instruction is certified for interagency use and is known as:

Firefighter Training, S-130
Certified at Level I

This product is part of an established NWCG curriculum. It meets the COURSE DEVELOPMENT AND FORMAT STANDARDS – Sixth Edition, 2003 and has received a technical review and a professional edit.

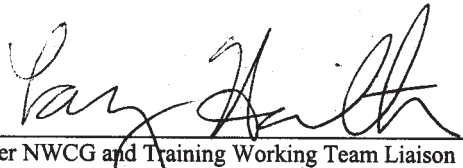

Member NWCG and Training Working Team Liaison

Date

12/22/03

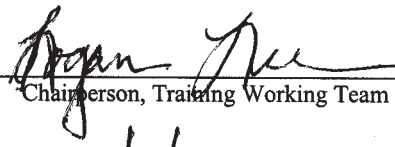

Chairperson, Training Working Team

Date

12/17/03

Description of the Performance Based System

The NWCG Wildland and Prescribed Fire Qualifications System is a “performance-based” qualifications system. In this system, the primary criterion for qualification is individual performance as observed by an evaluator using approved standards. This system differs from previous wildland fire qualifications systems which have been “training based.” Training based systems use the completion of training courses or a passing score on an examination as a primary criteria for qualification.

A performance-based system has two advantages over a training based system:

- Qualification is based upon real performance, as measured on the job, versus perceived performance, as measured by an examination or classroom activities.
- Personnel who have learned skills from sources outside wildland fire suppression, such as agency specific training programs or training and work in prescribed fire, structural fire, law enforcement, search and rescue, etc., may not be required to complete specific courses in order to qualify in a wildfire position.

1. The components of the wildland fire qualifications system are as follows:

- a. Position Task Books (PTB) contain all critical tasks which are required to perform the job. PTBs have been designed in a format which will allow documentation of a trainee’s ability to perform each task. Successful completion of all tasks required of the position, as determined by an evaluator, will be the basis for recommending certification.

IMPORTANT NOTE: Training requirements include completion of all required training courses prior to obtaining a PTB. Use of the suggested training courses or job aids is recommended to prepare the employee to perform in the position.

- b. Training courses and job aids provide the specific skills and knowledge required to perform tasks as prescribed in the PTB.
- c. Agency Certification is issued in the form of an incident qualification card certifying that the individual is qualified to perform in a specified position.

2. Responsibilities

The local office is responsible for selecting trainees, proper use of task books, and certification of trainees, see appendix A of the NWCG Wildland and Prescribed Fire Qualification System Guide, PMS 310-1, for further information.

Firefighter Training

S- 130

Student Workbook

DECEMBER, 2003

NFES 2730

Sponsored for NWCG publication by the NWCG Training Working Team

Comments regarding the content of this publication should be directed to:
National Interagency Fire Center, National Fire Training Support Group, 3833 S. Development Ave., Boise, Idaho
83705. Email: nwec_standards@nifc.blm.gov.

Additional copies of this publication may be ordered from National Interagency Fire Center, ATTN: Great Basin
Cache Supply Office, 3833 South Development Avenue, Boise, Idaho 83705. Order NFES 2730.

PREFACE

Firefighter Training, S-130, is required training for qualification as a Firefighter 2 (FFT2) under the Wildland and Prescribed Fire Qualification System Guide, PMS 310-1.

The original Firefighter, S-130 course was developed in 1981 by an Interagency team and revised in 1994. The 2003 version updates that course and was developed by an interagency team composed of:

Ben Jacobs - National Park Service
Craig Cook - Bureau of Indian Affairs
Bobi Stiles - US Forest Service
Michelle Ellis - US Forest Service
Tom Adams - State of Oregon
Rich Mattingly - National Park Service
Shane Del Grosso - US Fish and Wildlife Service

Comments regarding this package or additional information should be addressed to:

nwcg_standards@nifc.blm.gov
National Interagency Fire Center
Fire Training
Training Standards Unit
3833 South Development
Boise, Idaho 83705

CONTENTS

PREFACE	i
CONTENTS	iii
INTRODUCTION	1
DETAILED LESSON OUTLINES	
Unit 0 - Introduction	
Lesson A - Logistics and Overview	0A.1
Lesson B - Basic Terminology	0B.1
Unit 1 - Firefighter Preparedness	1.1
Unit 2 - ICS Overview	2.1
Unit 3 - Resource Types	3.1
Unit 4 - Risk Management	
Lesson A - Watch Out Situations and Fire Orders	4A.1
Lesson B - LCES	4B.1
Lesson C - Fire Shelter	4C.1
Lesson D - Potential Hazards and Human Factors on the Fireline (L-180)	4D.1
Unit 5 - Transportation Safety	5.1
Unit 6 - Hand Tools	6.1
Unit 7 - Firing Devices	7.1
Unit 8 - Use of Water	8.1

Unit 9 - Suppression	9.1
Unit 10 - Patrolling and Communication	
Lesson A - Patrolling	10A.1
Lesson B - Radio Communication	10B.1
Unit 11 - Mopup and Securing the Fireline	11.1
Unit 12 - Fire Exercise	12.1
Unit 13 - Hazardous Material Awareness	13.1
Unit 14 - Wildland/Urban Interface Safety	14.1
Unit 15 - Pump Operations (Optional)	15.1
Unit 16 - Map Reading and Use of the Compass (Optional)	16.1
Unit 17 - Wildland Fire Investigation (Optional)	17.1
Unit 18 - Cultural Resources (Optional)	18.1

INTRODUCTION

This course, Firefighter Training, S-130 and Introduction to Wildland Fire Behavior, S-190, are required training for all personnel prior to certification as a Firefighter (FFT2) under the Wildland and Prescribed Fire Qualification System Guide, PMS 310-1. An adapted version of L-180, Human Factors on the Fireline, has been included as part of this course. This entry-level course for all new firefighters can also be used as a refresher course for returning firefighters.

The purpose of this course is to train new firefighters in basic firefighting skills. Firefighters who successfully complete this course and the Work Capacity Test will be qualified to suppress wildland fires **WHILE UNDER CLOSE SUPERVISION**.

This course has been designed to be presented by qualified instructors at any location.

FIREFIGHTER TRAINING, S-130

Unit 0 - Introduction

Lesson A - Logistics and Overview

OBJECTIVE:

- Introduce the Firefighter Training course.

COURSE OBJECTIVES

- Explain what the LCES (Lookouts, Communications, Escape Routes, and Safety Zones) system is and how it relates to the Standard Firefighting Orders.
- Construct fireline to required standards using various methods.
- Strengthen, reinforce, and use holding actions on a fireline.
- Extinguish the fire with or without the use of water.
- Complete assigned tasks in a safe and efficient manner.
- Given an assignment in a wildfire environment, describe factors in that environment which could impact safety.

COURSE EVALUATION

Students will be evaluated by the following methods:

- Performance testing
- Oral/written quizzes
- Instructor observation

Some items will be evaluated on a “pass or fail” basis. Others will be evaluated on a percentage basis; for those, a score of 70% or higher is required.

Evaluation methods will be explained to the students at the beginning of each unit/lesson, if applicable.

FIREFIGHTER TRAINING, S-130

Unit 0 - Introduction

Lesson B - Basic Terminology

OBJECTIVES: Upon completion of this unit, students will be able to:

1. Identify nine parts of a fire.
2. Define nine fire behavior terms.
3. Discuss five other useful firefighting terms.

PARTS OF THE FIRE

Origin – the location where the fire started.

Head – shows the direction in which the fire is burning. This is the hottest and most active part of the fire.

Flank (right and left) – Sides of the fire, parallel to the main direction of spread. May have active fire, but not as hot as the head of the fire.

Rear/Heel – Opposite the head of the fire and burning less vigorously, if at all. Often near the fire origin.

Perimeter – Boundary line of the fire or fire edge. May not have active fire on some portions.

Finger – An area, usually a narrow strip, that burns away from the main part of the fire. Could be dangerous if personnel working the fire are flanked by a finger.

Pocket – Unburned area between the main fire and any fingers.

Island – Area of unburned fuel inside the fire perimeter.

Spot Fire – Burning area outside the main fire perimeter, often caused by wind blown embers or rolling debris.

PARTS OF THE FIRE

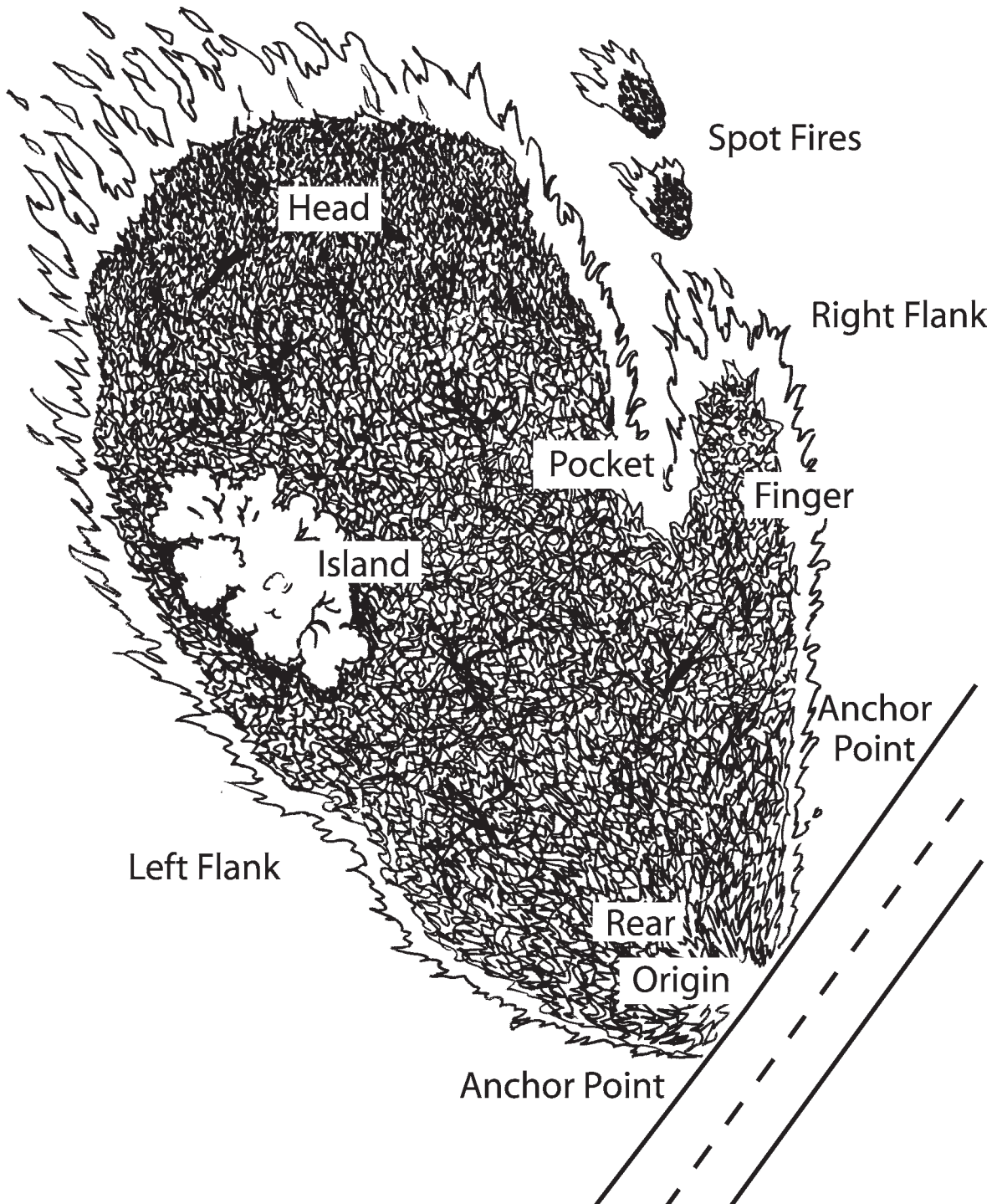

FIRE BEHAVIOR TERMS

Spread – Movement of the fire. ROS is Rate of Spread and given in chains per hour. A chain is a surveying term and equals 66 feet. A good rule of thumb is to watch the fire spread for a minute as there are 60 minutes in an hour and just over 60 feet in a chain so this will give a fairly quick, relatively accurate measurement of the fire's forward progress (ex. 1 foot/minute = 1 chain/hour).

Smoldering – Fire burning without flame and barely spreading.

Creeping – Fire burning with a low flame and spreading slowly.

Running – Fire spreading rapidly with a well-defined head.

Backing – Fire moving away from the head, downhill, or against the wind.

Spotting – Sparks or embers produced by the main fire are carried by winds or convection column.

Torching – Fire burning on the surface, but periodically igniting the crown of a single or small group of trees or shrubs before returning to the surface. Although sometimes confused with crowning this behavior is not as serious as a crown fire.

Crowning – Fire that advances across tops of trees or shrubs more or less independent of surface fire. High fire intensity and high forward rate of spread. Use crown fire or crowning with care because it describes a very serious fire situation.

Blowup – Sudden increase in fire intensity or rate of spread of a fire sufficient to preclude direct control or to upset existing suppression plans.

OTHER USEFUL FIREFIGHTING TERMS

Control Line – A comprehensive term used for all the constructed or natural fire barriers and treated fire edges used to contain the fire.

Fireline – Any cleared strip or portion of a control line from which flammable material has been removed by scraping or digging down to mineral soil.

Anchor Point – An advantageous location, generally a fire barrier, from which to start constructing a fireline. Used to minimize the chance of being outflanked by the fire while the line is being constructed.

Mopup – Final extinguishment of a fire after it is lined.

Class of Fire – This classifies the size of the fire with class “A” being the smallest and class “G” being the largest.

FIREFIGHTER TRAINING, S-130

Unit 1 - Firefighter Preparedness

OBJECTIVES: Upon completion of this unit, students will be able to:

1. Explain the importance of the proper use and maintenance of their assigned Personal Protective Equipment (PPE).
2. Develop a list of personal gear needed for an extended period away from their home station.
3. Explain the firefighter's accountability for personal and agency property.
4. List the benefits of maintaining a high level of physical fitness and health.
5. Explain how eating well and staying hydrated can reduce firefighter fatigue.
6. Explain the importance of keeping personal gear and assigned area in fire camp clean and organized.

I. INTRODUCTION

II. PERSONAL GEAR

A. Weight Limits:

Total individual gear weight = 65 pounds

Personal gear weight = 45 pounds

Web gear weight = 20 pounds (weight is without water)

B. Mandatory Items: Personal Protective Equipment (PPE)

1. Hard hat
2. Eye protection
3. Hearing protection
4. Gloves
5. Flame-resistant clothing - Nomex™
 - a. Trousers (Flame resistant)
 - b. Shirts (Flame resistant)
6. Boots
Leather work boots, lace-up, 8" high, heavy soles with deep tread, leather laces
7. Socks
8. Fire shelter with vinyl cover
9. Canteens (for drinking fluids only)
10. Head lamp, with fresh/spare batteries and spare bulb

11. Chain saw chaps (if assigned as a chainsaw operator or swamper)
12. First aid kit
13. Flat (bastard) files, 10" or 12"
14. Food, 1-2 meals minimum, preferably high energy
15. Personal gear pack (red bag)
16. Sleeping bag
17. Incident Response Pocket Guide

C. Optional Items

1. Hard hat shroud
2. Tent
3. Jacket or coat
4. Extra clothing (pants, shirts and socks)
5. Personal hygienic gear
6. Small “ditty bag” packed with some personal items and a fire shirt.

D. Other personal items. Some simple items will make your job easier and will add little to the overall pack weight. These items include:

1. Matches (in a waterproof container)
2. Watch
3. Pocketknife

4. Eyeglasses (if needed)/sunglasses
5. Prescriptions (if needed)
6. Water (one gallon per day/minimum)
7. Rain gear
8. Compass
9. Toilet paper
10. Spare boot laces
11. Bandanas
12. Flip flops for use in the showers to prevent athlete's foot
13. Small towel
14. Small flashlight
15. Instant hand sanitizer

III. ACCOUNTABILITY

Firefighters will be issued gear worth more than \$500. Firefighters are responsible for the proper use and maintenance of issued property.

The agency will not be held responsible for any personal gear not necessary for use in fire activity.

Care and Maintenance of personal and government issued equipment:

A. Hard hat

1. Keep headband and straps clean.
2. Do not modify.
3. Clean hats with soap and water.
4. Inspect for cracks and damage.

B. Nomex™ (fire resistant) clothing

1. Keep clean - Nomex™ loses its fire retardant capabilities if foreign substances are on or in the fibers. Check tag for washing instructions. Wash separately.
2. Replace clothing if ripped or torn.

C. Boots

1. Keep clean and apply boot grease as necessary.
2. Insure that boots are in good repair. This should include inspecting and replacing soles, insuring all stitching is present, etc.

IV. FIREFIGHTER FITNESS AND HEALTH

A. Introduction

REMEMBER, WHEN PEOPLE GET TIRED, THAT IS WHEN THEY GET HURT!

B. Physical Fitness

Aerobic fitness - is a measure of the maximum amount of oxygen that one can take into their body and transport to the muscles.

Muscular fitness - includes both strength and muscular endurance.

C. Diet

Firefighters can burn up to 300-600 calories an hour and over 6,000 calories a day. Daily caloric intake should equal expenditure. The key to a good diet is a balanced one that includes food in all the main food groups.

1. Carbohydrates
2. Fat
3. Protein
4. Fiber
5. Calcium
6. Vitamins and minerals

7. Sodium

8. Caffeine

9. Hints for a good performance:

- Avoid alcohol.
- Avoid eating red meat two days in a row.
- Limit egg intake to one per day.
- Eat whole wheat bread instead of white.
- Substitute other seasonings for salt.
- Eat ample amounts of fruit and vegetables.
- Avoid large amounts of sugar calories.
- Concentrate on getting enough carbohydrates.

D. Fluids

1. Symptoms of dehydration are:

- Morning headaches
- Diminished or discoloration of urine
- Diminished sweating
- Constipation
- Irritability

2. Firefighters can minimize dehydration by doing the following:

- THE BEST THING YOU CAN DO IS LOAD UP ON WATER.
- Keep a canteen by your side at all times, including while bedding down.
- Use electrolyte replacing drinks in moderation.
- Avoid excessive soft drinks and caffeine.
- Avoid alcohol completely when on fire assignments.
- Drink herbal teas as a hot drink if available instead of coffee.
- Utilize supplemental carbohydrates during sustained exercise.
- Avoid performance enhancing supplements containing caffeine, ephedrine, and creatine which increase the risk of heart related injuries.

E. Fatigue

1. Symptoms of fatigue are:

- Feeling rundown and groggy in the morning.
- Falling asleep at every break given.
- Feeling light headed and having difficulty concentrating.
- Irritability.
- Dulling of the senses (resulting in a reduction in situation awareness).

2. Firefighters can minimize fatigue by doing the following:
 - Maintain adequate food and water intake.
 - Pace work output while maintaining a steady rate of productivity.
 - Maintain 2 to 1 work to rest cycle.
 - Sleep whenever given the opportunity, avoid staying up late in fire camp when it is unnecessary.
 - **MONITOR YOURSELF AND YOUR CO-WORKERS.**

F. Personal Hygiene and Area Cleanliness

1. Ways to maintain personal hygiene and prevent sickness from spreading through a fire crew:
 - **WASH HANDS FREQUENTLY!!!**
 - Shower when given the opportunity.
 - Avoid sneezing and coughing on each other.
 - Change socks and underwear frequently.
 - Use foot powder.
 - Monitor yourself and co-workers for signs of sickness.
 - Supplement diet with Vitamin C, Echinacea, zinc, and multi-vitamins if you are feeling fatigued and have early symptoms of sickness.

2. Keeping your personal gear and assigned area in fire camp clean and organized has the advantage of:

- Maintaining a professional appearance for the crew.
- Being prepared to move on short notice.
- Lessening the chance of losing items.
- Minimizing impact to the environment.

FIREFIGHTER TRAINING, S-130

Unit 2 - Introduction to ICS

OBJECTIVES: Upon completion of this unit, students will be able to:

1. Describe the firefighter's chain of command.
2. Define an incident and describe how the incident management structure is organized.
3. Describe the general responsibilities of each section in the Incident Command System (ICS).
4. Name the two positions above the firefighter in the chain of command.

I. WHAT IS INCIDENT COMMAND SYSTEM?

- A. Management tool for responding to emergency situations. It establishes the chain of command.
- B. It is adaptable to many types of incidents (flood, hurricane, wildfire, search and rescue).
- C. It is adaptable to the size of the incident. It can grow to meet the needs of the incident while maintaining span of control.

II. CHAIN OF COMMAND

- A. Small Fire Organization
- B. Span of Control
- C. Building up to a 20-Person Handcrew Organization

III. LARGE FIRE MANAGEMENT ORGANIZATION

- A. Fire Progression
- B. Incident Command System

The incident is organized into the following five functional areas called sections:

- Command

- Operations
- Planning
- Logistics
- Finance/Administration

C. Incident Types

- Structure fire
- Search and rescue
- Flood
- Hurricane response
- Hazardous materials spill
- Vehicle accident
- Wildland fire
- Nationally declared emergency

IV. ICS SECTIONS RESPONSIBILITIES

A. Command

1. This section has overall responsibility and decision-making for an incident.
2. Positions in the command section include:
 - a. Incident commander

- b. Safety officer
- c. Information officer
- d. Liaison officer

B. Operations Section

1. Operations section develops and implements the strategy and tactics.
2. Positions in operations section include:
 - a. Operations section chief
 - b. Operations branch director
 - c. Division/Group supervisor
 - d. Task force leader
 - e. Strike team leader (tractor/plow, dozer, engine, crew)
 - f. Crew representative
 - g. Single resource boss (crew, engine, dozer, felling, firing, tractor/plow)
 - h. Advanced firefighter/squad boss
 - i. Firefighter
 - j. Air operations positions
 - k. Staging area manager
3. Operations may be divided geographically or functionally to maintain span of control.

C. Planning Section

1. Responsible for documenting and displaying the approved strategy and tactics for the incident.
2. The planning section includes:
 - a. Planning section chief
 - b. Situation unit
 - c. Resources unit
 - d. Documentation unit
 - e. Demobilization unit
 - f. Human resource specialist
 - g. Fire behavior analyst
 - h. Field observer
 - i. Other miscellaneous positions

D. Logistics Section

1. Responsible for providing support and service for all incident personnel.
2. The logistics section includes:
 - a. Logistics section chief
 - b. Communications unit
 - c. Supply unit

- d. Medical unit
- e. Food unit
- f. Facilities unit
- g. Ground support unit
- h. Other miscellaneous positions

E. Finance/Administration Section

- 1. Responsible for processing payments, purchasing, contracts and providing cost estimates.
- 2. The finance section includes:
 - a. Finance/Administration section chief
 - b. Cost unit
 - c. Procurement unit
 - d. Compensation/claims unit
 - e. Time unit
 - f. Commissary manger
 - g. Other miscellaneous positions

FIREFIGHTER TRAINING, S-130

Unit 3 - Resource Types

OBJECTIVES: Upon completion of this unit, students will be able to:

1. Explain different types of crew organizations commonly used in initial attack and extended attack.
2. Explain the importance of respecting cultural differences in terms of food, standards of behavior, dress, and customs.

I. INTRODUCTION

A. Firefighter Duties and Responsibilities

1. Performs manual and semi-skilled labor.
2. Ensures that objectives and instructions are understood.
3. Performs work in a safe manner.
4. Maintains self in the physical condition required to perform the arduous duties of fire suppression.
5. Keeps personal clothing and equipment in serviceable condition.
6. Reports close calls, accidents or injuries to supervisor.
7. Reports hazardous conditions to supervisor.

B. Crew Organization

1. Establishes chain of command.
2. Provides pre-planned job assignments.
3. Creates teamwork.
4. Gives individuals responsibility.
5. Reduces confusion.
6. Saves time.
7. Maintains control.
8. Builds esprit de corps.

9. Creates respect among crew members.

II. TYPES OF CREWS

A. Hand Crews

Organized Type 1 and 2 crews must be 18-20 persons.

1. Type 1 hand crews
2. Type 2 hand crews

B. Engine Crews

Types of engines and crew configurations:

1. Type 1, 1000 gallon per minute (GPM), 400 gallon tank capacity, 4 crewmember minimum.
2. Type 2, 500 GPM, 400 gallon tank capacity, 3 crewmember minimum.
3. Type 3, 120 GPM, 300 gallon tank capacity, 2 crewmember minimum.
4. Type 4, 70 GPM, 750 gallon tank capacity, 2 crewmember minimum.
5. Type 5, 50 GPM, 500 gallon tank capacity, 2 crewmember minimum.

6. Type 6, 50 GPM, 200 gallon tank capacity, 2 crewmember minimum.
7. Type 7, 20 GPM, 125 gallon tank capacity, 2 crewmember minimum.

C. Helitack Crews

1. Type 1 Helicopter (e.g., Bell 214, Sikorsky S-61), 16 seats, manager only.
2. Type 2 Helicopter (e.g., Bell 205, Bell 212), 10 seats, manager and three crew persons.
3. Type 3 Helicopter (e.g., Bell 206, Hughes 500D, 500E, Hiller 12 E, Bell 47), 3-5 seats, manager and two crew persons.

D. Dozers/Tractor Plow Crews

Classifications range from Type 1 dozers being the heaviest to Type 3 being the lightest, and tractor plows Type 6 is the lightest.

III. CULTURAL DIFFERENCES

A. Areas of Cultural Differences

B. Other Social and Ethnic Considerations

FIREFIGHTER TRAINING, S-130

Unit 4 - Risk Management

Lesson A - Watch Out Situations and Standard Firefighting Orders

OBJECTIVES: Upon completion of this lesson, students will be able to:

1. Identify the common denominators on tragedy fires.
2. Given a scenario, identify the appropriate Watch Out Situations.
3. Apply appropriate Standard Firefighting Orders to minimize the potential for serious injury or death.

I. INTRODUCTION

Common Denominators of Fire Behavior on Fatal and Near-Fatal Fires
Such fires often occur:

- On relatively small fires or isolated areas of large fires.
- In deceptively light fuels, such as grass, herbs, and light brush.
- When fire responds to topographic conditions and runs uphill.
- When there is an unexpected shift in wind direction or in wind speed.

II. WATCH OUT SITUATIONS

A. Watch Out Situations

1. FIRE NOT SCOUTED AND SIZED UP.

Why is this important?

2. IN COUNTRY NOT SEEN IN DAYLIGHT

Why is this important?

What can you do if you cannot wait to see the country in daylight?

3. SAFETY ZONES AND ESCAPE ROUTES NOT IDENTIFIED.

Why is this important?

4. UNFAMILIAR WITH WEATHER AND LOCAL FACTORS INFLUENCING FIRE BEHAVIOR.

Why is it important?

Weather patterns - Do all fires have them?

How do you obtain this local information?

5. UNINFORMED ON STRATEGY, TACTICS AND HAZARDS.

What does strategy mean?

What are tactics?

What hazards need to be identified?

What questions can be asked to reduce the risks?

6. INSTRUCTIONS AND ASSIGNMENT NOT CLEAR.

What should your instructions include?

7. NO COMMUNICATION LINK WITH CREW MEMBERS/
SUPERVISOR.

Why must you be in communication?

8. CONSTRUCTING FIRELINE WITHOUT SAFE ANCHOR
POINT.

What is a safe anchor point?

9. BUILDING FIRELINE DOWNHILL WITH FIRE BELOW.

What is the danger in building line downhill?

Can you ever build line downhill?

10. ATTEMPTING FRONTAL ASSAULT ON FIRE.

What are the dangers involved with a frontal assault?

11. UNBURNED FUEL BETWEEN YOU AND THE FIRE.

Why is this a “watch out situation?”

How can you prevent this potential problem?

12. CANNOT SEE MAIN FIRE, NOT IN CONTACT WITH ANYONE WHO CAN.

Why is this important?

13. ON A HILLSIDE WHERE ROLLING MATERIAL CAN IGNITE FUEL BELOW.

What are the consequences?

14. WEATHER IS GETTING HOTTER AND DRIER.

Why is this a “watch out situation?”

How can you tell if it is getting hotter and drier?

15. WIND INCREASES AND/OR CHANGES DIRECTION.

Why is this a “watch out situation?”

16. GETTING FREQUENT SPOT FIRES ACROSS LINE.

What are the consequences of spot fires?

17. TERRAIN AND FUELS MAKE ESCAPE TO SAFETY ZONES DIFFICULT.

Why is this a “watch out situation?”

18. TAKING A NAP NEAR FIRELINE.

Although this is a convenient place what danger might there be?

III. STANDARD FIREFIGHTING ORDERS

1. Keep informed on fire weather conditions and forecasts.
2. Know what your fire is doing at all times.
3. Base all actions on current and expected behavior of the fire.
4. Identify escape routes and safety zones, and make them known.
5. Post lookouts when there is possible danger.
6. Be alert. Keep calm. Think clearly. Act decisively.
7. Maintain prompt communications with your forces, your supervisor and adjoining forces.
8. Give clear instructions and insure they are understood.
9. Maintain control of your forces at all times.
10. Fight fire aggressively, having provided for safety first.

A. #1 - Keep informed on fire weather conditions and forecasts.

Weather will most often dictate where and how your fire will move.

What weather factors are most important to know?

What personal observations can you make?

Where might you obtain “off-site” weather information?

- B. #2 - Know what your fire is doing at all times.

Observe, use lookouts and scouts. This is the basic order that all orders fall back on.

What current information on the fire’s status do you need to know?

How do you obtain this information?

- C. #3 - Base all actions on current and expected behavior of the fire.

Fire is not static. It will constantly move and grow until it is controlled. Once you have sized up the fire, begin to anticipate its movements. Current and expected fire behavior will help you do this.

When applying this Standard Firefighting Order, what fire behavior elements are considered?

What time of the day are burning conditions most active and why?

Where would most active burning take place for any operational period?

D. #4 - Identify escape routes and safety zones, and make them known.

This order must be in place before firefighters can become engaged. If the fire situation deteriorates, you can always move to a safety zone until the situation becomes clear to you.

What would you consider when identifying escape routes and safety zones?

E. #5 - Post lookouts when there is possible danger.

*A lookout will be able to tell you **what your fire is doing**. The lookout can also take weather readings to help you predict future fire behavior.*

What things would you consider when assigning a lookout?

F. #6 - Be alert. Keep calm. Think clearly. Act decisively.

You must first be clear and calm in your own mind to be safe and effective. If you are confused then move to a safety zone until the situation is clear again. Remember all of us, no matter what our experience level, will be confused and unsure of ourselves at times on the line. There are often just too many variables changing too fast for our minds to process. If you are confused, then move to your safety zone to watch and learn.

What factors in the fire environment might adversely affect our alertness, thinking, judgment, and decision making ability?

What can you do to prevent or reduce the effect of the following factors?

Fatigue and heat stress?

Carbon Monoxide?

Stress?

What should you do to increase your decision making ability?

- G. #7 - Maintain prompt communications with your forces, your supervisor and adjoining forces.

If your communication lines are broken then stop and take time to re-evaluate until the lines are open again.

Who do you need to stay in communication with?

What information do you need?

H. #8 - Give clear instructions and ensure they are understood.

When in doubt, ask for clarification of instructions.

Whose responsibility is it to ensure instructions are given and understood?

How do you “ensure understanding?”

I. #9 - Maintain control of your forces at all times.

How do you “maintain control?”

J. #10 - Fight fire aggressively, having provided for safety first.

What safety considerations need to be taken into account prior to fighting fire aggressively?

IV. SUMMARY

WATCH OUT SITUATIONS SCENARIO

The scenario you are about to see portrays a tragic fire that occurred in the eastern region of the United States. Watch Out Situations were not observed and/or mitigated. Firefighters lost their lives.

In analyzing this scenario, you are reaping the only benefit that can ever be salvaged from a fire tragedy: a learning experience, to minimize the possibility that this could happen to you.

You will have the opportunity to recognize and react to “Watch Out Situations.” Awareness of these hazardous situations is your key to survival in the wildland fire environment.

It is important that you look and listen at a high sensitivity level. Clues, both visual and verbal, will be apparent in this scenario, providing indicators that “Watch Out Situations” are present. Use the checklist on the following page to record your observations.

When the video/DVD is shut off, the class will work together as a group to answer the attached questions.

WATCH OUT SITUATIONS CHECKLIST

- _____1. Fire not scouted and sized up.
- _____2. In country not seen in daylight.
- _____3. Safety zones and escape routes not identified.
- _____4. Unfamiliar with weather and local factors influencing fire behavior.
- _____5. Uninformed on strategy, tactics and hazards.
- _____6. Instructions and assignments not clear.
- _____7. No communication link with crew members/supervisor.
- _____8. Constructing fireline without safe anchor point.
- _____9. Building fireline downhill with fire below.
- _____10. Attempting frontal assault on fire.
- _____11. Unburned fuel between you and the fire.
- _____12. Cannot see main fire, not in contact with anyone who can.
- _____13. On a hillside where rolling material can ignite fuel below.
- _____14. Weather is getting hotter and drier.
- _____15. Wind increases and/or changes direction.
- _____16. Getting frequent spot fires across line.
- _____17. Terrain and fuels make escape to safety zones difficult.
- _____18. Taking a nap near the fireline.

WATCH OUT SITUATIONS SCENARIO QUESTIONS

1. Which Watch Out Situations did you observe?

2. Was there an adequate briefing with Engine 731?

3. Why should weather and fuel conditions be part of the daily briefing?

4. What can crew members do if information is missing from the briefing?

5. Describe any other events you observed that contributed to the tragedy.

6. Why is it important to know what is happening on other divisions of the fire?

7. What is your number one priority?

FIREFIGHTER TRAINING, S-130

Unit 4 - Risk Management

Lesson B - LCES

OBJECTIVES: Upon completion of this lesson, students will be able to:

1. Describe how Lookouts, Communications, Escape routes and Safety zones (LCES) is related to the Standard Firefighting Orders.
2. Define escape route, escape time, and safety zone.
3. Identify travel barriers that will affect escape time.
4. List the three types of safety zone categories and describe one example of each.
5. Describe a general guideline for determining safety zone size to avoid radiant heat injury.
6. Identify the limitations of utilizing the Incident Response Pocket Guide safety zone guidelines.
7. Describe the difference between deployment sites and safety zones.

I. LCES AND THE 10 STANDARD FIREFIGHTING ORDERS

A. Lookouts

Black Water Fire - 1937, Wyoming. 15 Civilian Conservation Crew members killed.

Discussion topics

1. What would have posting lookouts done for the firefighters in this case?
2. What does the lookout need to be able to see?
3. Who should be selected as a lookout?
4. How many lookouts are needed?

B. Communications

Battlement Creek Fire - 1976, Colorado. Three hotshots killed.

1. What was the main contributing factor to this accident?

2. What are some barriers to communication?

3. The method used to alert firefighters of approaching hazards must be what?

4. What communication devices/methods could be used?

C. Escape Routes

Loop Fire - 1966, California. 12 hotshot crew members killed and another 9 were injured.

1. What was this crew attempting to do?

2. What happened?

3. How could escape routes have been established to avoid this tragedy?

4. How would you define an escape route?

5. What is escape time?

6. What are some travel barriers you might encounter that will increase escape time?

7. When might you need to reevaluate or change your escape routes?

8. How many escape routes should be available to the firefighter? Why?

D. Safety Zones

1. What is a safety zone?

2. Safety zone categories
 - a. The burn
 - b. Natural features
 - c. Constructed features

3. Examples of these types of safety zones may include (refer to PowerPoint slides):
 - a. The burn:

 - b. Natural:

 - c. Natural:

 - d. Natural:

 - e. Constructed:

 - f. Constructed:

- g. Constructed:
- h. Constructed (agricultural):
- i. Constructed (agricultural):
- j. Constructed (forestry):
- k. Constructed (urban):

4. Determining the size and location of an effective safety zone.

Safety zones must be pre-located to avoid:

- Locations that are downwind from the fire.
- Locations that are in chimneys, saddles or narrow canyons.
- Locations that require a steep uphill escape route (greater than 50% slope).
- Exposure to heavy fuel concentrations on the windward side of ridges, rocks and other solid objects.

The IRPG table assumes no slope or wind. Convection is not addressed. Convective heat transfer from wind, fire whirls and terrain influences will significantly increase the total heat transfer to firefighters and thus require significant increases in the distance separation guidelines.

E. Scenario - Safety Zones

During the fire season of 2001 fourteen firefighters and two civilians deployed their fire shelters while battling the Thirtymile Fire on the Okanogan-Wenatchee National Forest. Their only escape route was cut off and they retreated up canyon to what was believed to be a safety zone.

The site was approximately ½ acre (100 feet by 100 feet) in size located adjacent to a rock talus and riparian vegetation. The fire burned as a crown fire resulting in flame lengths 60-100 feet high.

II. DEPLOYMENT SITES VS. SAFETY ZONES

A. What is a deployment site and when should it be used?

1.

2.

3.

B. Determining when to seek refuge may or may not be easily identifiable to all fire fighters.

C. Scenarios

1. This photo of the Butte Fire shows the steep ridge with continuous heavy fuels below the ridge line. Crews assigned to this section of the control line were to fire off and secure control lines.

What factors need to be evaluated to determine if this is a deployment site or a safety zone?

2. We have previously identified these photos as natural safety zones. In the first photo if the large pine trees torched out would your opinion change? Why?

The second photo shows timber in the background that may be prone to extreme fire behavior. Would time of day affect your opinion of this meadow as a safety zone? Why?

FIREFIGHTER TRAINING, S-130

Unit 4 - Risk Management

Lesson C - Fire Shelter

OBJECTIVES: Upon completion of this lesson, students will be able to:

1. Explain the two most important functions of the fire shelter.
2. Discuss the inspection and care of the fire shelter.
3. Discuss the last resort survival options.
4. Discuss entrapment and deployment site.
5. Demonstrate the correct deployment procedures for the fire shelter in 25 seconds or less.

I. INTRODUCTION

A. Two Most Important Functions of the Fire Shelter

1. To reflect radiant heat. It is NOT designed for direct flame contact.
2. To provide cooler, breathable air to protect your lungs and airway.

B. Mandatory Carrying

A fire shelter will be carried by...

- all fireline personnel during all phases of fire suppression and prescribed fire operations.
- all fire support personnel, such as drivers, who may be required to enter a fire area.

C. Items to Wear and Take into Fire Shelter

1. Gloves
2. Radio
3. Hard hat
4. Water

II. SHELTER INSPECTION AND CARE

A. Visual Inspection of the Shelter in the Polyethylene Case (should be made):

1. When the fire shelter is issued to you.
2. At the beginning of each fire season.
3. Every two weeks during the fire season.

B. Fire Shelter Damage

1. Abrasion is the most common damage. Signs of abrasion include:
 - a. Gray vinyl bag through which you cannot see the shelter, or visible dark gray stains.
 - b. Aluminum particles in the bottom of the bag.
2. Other signs of damage include:
 - a. Tears along folded edges exceeding 1/4".
 - b. Dents or punctures in the foil over one-inch wide.
 - c. One-half inch or more of foil is missing.

C. Care and Handling

III. LAST RESORT SURVIVAL OPTIONS

A. Introduction

1. Stay alert, keep calm, think clearly and act decisively. **DON'T PANIC.**
2. Full PPE is required, especially a hard hat and gloves!
3. Protect your airway.
4. Escape if possible.
5. Make it a habit and part of your **situational awareness** to note survivable deployment sites throughout the work day.
6. Never plan to share a shelter.

B. **Entrapment is Imminent**, but there **is Time** to Prepare.

1. Drop any gear that will not be needed in the site preparation. The bare minimums should be the fire shelter, a tool for removing ground fuel, and some drinking water.
2. Avoid hazardous terrain and heavy fuels. Be aware of snags, rolling rocks and any area that may have vehicle travel.
3. Rivers, streams, ponds, lakes

4. Site preparation can reduce the potential fire intensity by improving the radiant heat distance separation.
 5. Individual site preparation considerations:
 - a. Seek the lowest point.
 - b. Greatest distance from the nearest fuels.
 - c. Smooth surface textures for shelter seal.
 - d. Utilize heat barriers.
 - e. Remove ground fuels (4' x 8').
 - f. Prepare to deploy as a crew with shelters grouped as close together as possible.
 6. Consider starting a burnout if you have time.
 7. Air resources may be an option, but may not always be available.
 8. Do not wait until the flame front is upon you to get into the shelter.
- C. No Time for Preparation, and the **Fire is on You.**
1. Immediately deploy if there are hot embers raining down on you.

2. You will be hit with a blast of superheated air before the flame front reaches you. To avoid the impact:
 - a. Drop to the ground as quickly as possible and do what ever it takes to get into your shelter.
 - b. Find the lowest point available and get you face down into the dirt.
 - c. Dig a shallow hole and use a dry bandana to breath through.
3. Position your feet toward the fire.
4. At all costs hang onto the shelter; the winds will be turbulent and powerful.
5. Be prepared for the long-haul; entrapments have lasted up to 90 minutes. Drink water and stay calm.
6. **Stay in your shelter.**
7. The noise will be horrendous.
8. Do not leave your shelter until it is cold to the touch, or told to do so by a supervisor.

D. Heat Barrier Options

1. Vehicles as barriers
2. Dozers, tractor plows, and water-tenders as barriers
3. Structures as barriers

VI. SUMMARY AND REVIEW

A. What is a Fire Shelter?

B. What a Fire Shelter is Not

C. Your Fire Shelter Must be Available and in Good Condition.

D. Fire Shelter Training Recommendations

1. Shelter training is mandatory every year.
2. Shelter deployment practice should occur several times during the fire season.

VII. APPLICATION/EVALUATION

FIREFIGHTER TRAINING, S-130

Unit 4 - Risk Management

Lesson D - Potential Hazards and Human Factors on the Fireline

OBJECTIVES: Upon completion of this lesson, students will be able to:

1. Define safety.
2. Define Situation Awareness and describe why it is important.
3. State the five communication responsibilities.
4. Identify potential hazards in the fire environment.
5. Define the Risk Management Process and describe why it is important.
6. Describe actions that foster teamwork.

I. INTRODUCTION

II. SAFETY

Defined in Webster's Dictionary as:

- A. The condition of being safe from undergoing or causing hurt, injury, or loss.
- B. A device on a piece of equipment to reduce hazard.
- C. Freedom from exposure to danger, exemption from injury, and to protect from injury.

III. HUMAN FACTORS ON THE FIRELINE

- A. Introduction
- B. Situation Awareness

VIDEO SEGMENT 1

1. What concepts discussed in this first video segment do you think are relevant to the job of firefighting?

2. How much "human factor" do you think is involved in a wildland firefighter's job?

3. Do you perceive human error as being a major factor when accidents occur? Do you think it will be any different on the fireline?
4. What is situation awareness (SA)?
5. Why should you, as a beginning firefighter, maintain good situation awareness?
6. Do you think maintaining your situation awareness on the fireline will be difficult? Why?
7. What happens when you become distracted in any work environment?

C. Communication

VIDEO SEGMENT 2

1. What is it about communication that is so important to you as beginning firefighters?
2. What is required for effective communication to take place?

3. What can you do as a beginning firefighter to help ensure that there is clear communication between you and your supervisor or if you are unsure of a situation?

4. What are some common communication barriers that you have experienced in your day-to-day lives?

VIDEO SEGMENT 3

5. As a beginning firefighter, you would most likely prefer to be addressed on the fireline with direct statements. Why are direct statements important?

VIDEO SEGMENT 4

6. Have you used standardized communication procedures in your work environments prior to firefighting?

VIDEO SEGMENT 5

7. Of the five communication responsibilities (briefing, debriefing, communicate hazards, acknowledge messages, ask if you don't know) which do you feel will apply most directly to you as a beginning firefighter?

8. As a beginning firefighter, would you ever feel reluctant to point out hazards to a more experienced crew member?

9. Should you be encouraged to ask questions in situations where you are unsure of what you are supposed to do?

10. How would you deal with a situation where you were discouraged from asking questions?

IV. THE FIRELINE ENVIRONMENT

A. Hazards in the fireline environment can be organized into two categories:

1. Subjective hazard
2. Objective hazard

Four frequently encountered and potentially fatal hazards in the fire environment:

-
-
-
-

B. Fire Environment Hazards

C. Human Related Hazards

- D. Other Environmental Hazards
- E. Biological Hazards
- F. Equipment Hazards
- G. Vehicle Hazards (trucks, dozers, tractor/plows)
- H. Aircraft (Rotor and Fixed-Wing) Hazards
- I. Base Camp Related Hazards
- J. Wildland/Urban Interface Hazards
- K. Tree and Snag Hazards

Visible categories or conditions of trees

- Living
- Dead (snags)

V. RISK MANAGEMENT PROCESS

A. STEP 1 - SITUATION AWARENESS

Is there any specific information that you, as a beginning firefighter, will want to know from your supervisor on every assignment?

B. STEP 2 - HAZARD ASSESSMENT

1. There are specific tools that help you identify hazards on the fireline work environment.
2. Do you have a professional responsibility to begin to learn how to identify hazards as a beginning firefighter?

C. STEP 3 - HAZARD CONTROL

1. We have basic rules of engagement on the fireline. These rules provide the primary hazard control/mitigations for all operations on the fireline.
2. There are four key operational components of the Standard Firefighting Orders that must always be in place when working on the fireline.

D. STEP 4 - DECISION POINT

1. Will you be making tactical decisions on the fireline?

2. Should you ask questions if you do not understand a decision being made?

3. If your supervisor tells you this is not a good time to ask questions because of the situation at hand, when is another time you could bring up your question?

E. STEP 5 - EVALUATE

1. Why do you think the risk management process must be continually evaluated?

2. Do you, as well as your supervisor, have a responsibility to continually evaluate the risks in your work environment?

VI. TEAMWORK

- A. What are some successful teams you have seen or been involved with prior to today?

- B. What were some characteristics of successful teams you have seen or been involved with?

- C. What were some characteristics of unsuccessful teams you have seen or been involved with?

- D. Why is teamwork so important in firefighting?

TEAMWORK GUIDELINES

- 1. Know Yourself and Seek Improvement.**
Responsibility to learn and improve
- 2. Be Technically and Tactically Proficient.**
Responsibility to reduce errors
- 3. Comply With Orders and Initiate Appropriate Actions in the Absence of Orders.**
Understand the intent of your assignment.
- 4. Develop a Sense of Responsibility and Take Responsibility for Your Actions.**
Admit your mistakes and learn from them.
- 5. Make Sound and Timely Decisions and Recommendations.**
Responsibility to be aware of your situation (S.A.)
Responsibility to minimize risk
Learn the risk management process.
- 6. Set the Example for Others.**
Make sure your actions as a firefighter are professional.
- 7. Be Familiar with Your Leader and Their Job, and Anticipate Their Requirements.**
Responsibility to learn and improve
- 8. Keep Your Leader Informed.**
Provide feedback when asked.
- 9. Understand the Task and Ethically Accomplish It.**
Seek clarification when intent is unclear.
- 10. Be a Team Member - But Not a “Yes Person.”**
Responsibility to work as a team member
Use all the communication tools.

FIREFIGHTER TRAINING, S-130

Unit 5 - Transportation Safety

OBJECTIVE: Upon completion of this unit, students will be able to:

- Develop a list of three safety procedures to follow when traveling by each of the following:
 - Vehicle
 - Boat
 - Helicopter
 - Fixed-wing aircraft
 - On foot

I. INTRODUCTION

II. VEHICLE TRAVEL

A. Loading

B. Riding

C. Unloading

III. BOAT TRAVEL

A. Loading

B. Riding

C. Unloading

IV. HELICOPTER TRAVEL

A. Loading

B. Riding

C. Unloading

V. FIXED-WING AIRCRAFT TRAVEL

If in a large transport aircraft, follow the directions of pilot and attendants.

For smaller aircraft:

- Remember the pilot is in command. Follow the pilot's instructions.
- Never open a door while in flight.
- Do not distract the pilot during take-off or landing.
- No smoking.
- Do not slam door shut; assure nothing is hanging outside the door that could cause damage.
- Fasten seat belt/shoulder harness.
- Know emergency egress procedure.

VI. EMERGENCY LANDING PROCEDURES FOR AIRCRAFT

Position yourself in the correct crash position as dictated by the pilot or helitack crew.

VII. FOOT TRAVEL

- A. Your supervisor will set the pace and select the route for your crew.
- B. Crew members must stay together.
- C. Maintain proper distance between crew members (10-feet).
- D. Hazards you will encounter while walking to or from the fire are:
 - 1. Darkness (hampers your ability to recognize many objects in time to avoid them).
 - 2. Your hand tools.
 - 3. Another person's hand tools.
 - 4. Falling trees, tree-tops, hanging loose debris from saws or tractors, fire or disease weakened trees.
 - 5. Leaning trees.
 - 6. Snags.
 - 7. Whipping branches.
 - 8. Rolling rocks or logs.
 - 9. Vehicles, heavy equipment, ATVs, aircraft working overhead.
 - 10. Unstable footing.
 - 11. Stream or canal crossings.
 - 12. Stump holes.

13. Local hazards (poisonous insects, snakes, or plants; polluted water).
14. Fire location (know where the fire is, follow your crew leader's directions in an emergency).

VIII. APPLICATION/EVALUATION

FIREFIGHTER TRAINING, S-130
UNIT 5 - TRANSPORTATION SAFETY
PERFORMANCE EVALUATION

Performance evaluation:

Observe students traveling during the training. Instructor may have students load and unload from vehicles and aircraft.

INSTRUCTOR CHECKLIST:

Score by placing a check mark in the box. Failure on any step or procedure constitutes failure of the exam.

- 1. PPE properly worn.
- 2. Safety measures taken (seat belts, life vests, etc.).
- 3. Tools and personnel separated.
- 4. Follows directions of appropriate personnel.
- 5. Appropriate spacing during foot travel.
- 6. Eye protection utilized where necessary.

FIREFIGHTER TRAINING, S-130

Unit 6 - Hand Tools

OBJECTIVES: Upon completion of this unit, students will be able to:

1. Given hand tools, personal protective equipment, and proper maintenance tools, check the condition of each item, perform field maintenance, and identify those needing replacement.
2. Demonstrate the proper sharpening techniques for commonly used tools.
3. Given a description of three fireline jobs and a choice of tools, state the tool that would be used for each job.
4. Demonstrate the proper methods of carrying and passing tools.
5. Demonstrate the proper spacing when using hand tools.
6. Demonstrate the proper placement, near a fireline, of one or more tools when not in use.
7. Given a swatter or gunnysack and personal protective equipment, check the condition of the fire swatter and perform field maintenance.

I. INTRODUCTION

II. CUTTING TOOLS

A. Single-bit Ax

1. Terminology/parts
2. Single-bit ax use
3. Single-bit ax sharpening

B. Pulaski

1. Pulaski terminology/parts
2. Pulaski use
3. Pulaski sharpening

C. Adz Hoe

1. Adz hoe terminology/parts
2. Adz hoe use
3. Adz hoe sharpening

III. GENERAL INSPECTION - CUTTING TOOLS

Tool head

- Cracks, gouges, wear and holding wedge
- Damaged cutting head
- Rust
- Safety guards

IV. SCRAPING TOOLS

A. Shovel (round point)

1. Shovel terminology/parts
2. Shovel use
3. Shovel grip and stance
4. Shovel care and maintenance

B. McLeod (kortick removable head)

1. McLeod terminology/parts
2. McLeod use

3. McLeod grip and stance

4. Care and maintenance

C. Combi Tool

1. Combi Tool terminology/parts

2. Combi Tool use

3. Combi Tool grip and stance

4. Combi Tool care and maintenance

D. Fire Rake (also known as a council tool/rake)

1. Fire rake terminology/parts

2. Fire rake use

3. Fire rake grip and stance

4. Fire rake care and maintenance

V. GENERAL SAFETY - HAND TOOLS

A. Utilizing Hand Tools

B. Sharpening Hand Tools

VI. GENERAL STORAGE - HAND TOOLS

A. Safety Guards

B. Vehicles

C. Proximity to Fireline

VII. APPLICATION/EVALUATION

VIII. ALTERNATIVE TOOLS

A. Swatter (flapper)

1. Swatter terminology

2. Swatter use

3. Swatter grip and stance
4. Swatter care and maintenance.
5. Swatter storage

B. Gunnysack/Burlap

1. Gunnysack use
2. Gunnysack grip and stance
3. Gunnysack care and maintenance
4. Gunnysack storage

IX. APPLICATION/EVALUATION

FIREFIGHTER TRAINING, S-130
UNIT 6 - HAND TOOLS
PERFORMANCE EVALUATION

Performance evaluation:

Demonstrate the proper procedures for carrying commonly used scraping tools and for passing crew members while working with these tools.

INSTRUCTOR CHECKLIST:

Score by placing a check mark in the box. Failure on any step or procedure constitutes failure of the exam.

- 1. PPE properly worn.
- 2. Maintains proper spacing.
- 3. Carries tool on the downhill side.
- 4. Cutting edge is away from body.
- 5. McLeod is carried with cutting edge up.
- 6. Signal prior to passing crew members.
- 7. Wait to be given right-of-way.

FIREFIGHTER TRAINING, S-130
UNIT 6 - HAND TOOLS
PERFORMANCE EVALUATION

Performance evaluation:

Demonstrate the proper grip, stance and use of an alternative tool.

INSTRUCTOR CHECKLIST:

Score by placing a check mark in the box. Failure on any step or procedure constitutes failure of the exam.

- 1. PPE properly worn.
- 2. Tool lightly patted or dragged along fire edge.
- 3. Constant movement to prevent burning.
- 4. Firm grip.
- 5. Feet apart, solid stance.
- 6. Eyes on target.

FIREFIGHTER TRAINING, S-130
UNIT 6 - Hand Tools

UNIT 6 QUIZ
(30 possible points)

1. List five commonly used hand tools. (5 points)

2. Identify the maintenance procedures for the following conditions of tool handles and tool heads. (8 points)

HANDLE/CONDITION CHECK

MAINTENANCE

Tool handle is not straight.

Tool handle is not smooth.

Tool handle is cracked.

Retaining bolts/pins are not tight.

Tool head is loose.

Tool head is dull.

Tool head is chipped.

Tool blade is bent.

3. Describe the proper safety techniques for sharpening and field maintenance of tools. (3 points)

4. Describe the proper method of carrying hand tools commonly used in your area. (3 points)

5. Using the list of hand tools below, select which hand tools you would use for each of the fireline tasks (multiple answers may apply). (5 points)

Hand Tools:

- a. Shovel
- b. Pulaski
- c. Fire swatter
- d. Adze Hoe
- e. Ax
- f. McLeod
- g. Fire rake

Tasks:

Hand Tools:

Limbing a spruce tree.

Constructing a line in a hardwood forest.

Knocking down flame in light cheatgrass.

Digging line in tundra

Falling a 3"-6" diameter tree in a primitive area.

6. Demonstrate or describe the proper method of passing hand tools commonly used in your area. (2 points)

7. What is the minimum spacing while working or walking with a handtool? (2 points)

8. Describe proper placement of commonly used tools when they are not needed in fireline construction. (2 points)

Tools should:

FIREFIGHTER TRAINING, S-130

Unit 7 - Firing Devices

OBJECTIVES: Upon completion of this unit, students will be able to:

1. Describe two hazards to operators when using a fusee.
2. Demonstrate or simulate how to ignite, use, and extinguish a fusee.
3. Describe four hazards to operators when using a drip torch.
4. State the proper fuel mixture for a drip torch.
5. Prepare a drip torch for use and ignite.
6. Demonstrate the safe use of the drip torch.
7. Extinguish a drip torch and prepare it for storage.
8. Describe two field expedient methods for igniting wildland fuels.

I. FUSEE

A. Fusee Terminology

B. Fusee Features

C. Fusee Use

D. Fusee Care and Maintenance

E. Fusee Safety

F. Fusee Storage

II. DRIP TORCH

A. Drip Torch Terminology

B. Drip Torch Use

C. Drip Torch Care and Maintenance

D. Safety

III. FIELD EXPEDIENT METHODS OF IGNITING WILDLAND FUELS

A. Methods of Ignition

B. Safety

FIREFIGHTER TRAINING, S-130
UNIT 7 - FUSEE PERFORMANCE EVALUATION

The student will provide an oral response to the following question. The question and performance evaluation are pass/fail.

List two hazards to operators when using a fusee.

Performance evaluation:

Given a fusee and a cleared area, demonstrate (1) igniting a fusee, (2) igniting wildland fuel, and (3) extinguishing the fusee.

CHECKLIST:

Score by placing a check mark in the box. Failure on any step or procedure constitutes failure of the exam.

- 1. Sleeves down, gloves on and eye protection in place.
- 2. Remove striker protector.
- 3. Expose igniter.
- 4. Place striker on igniter.
- 5. Turn face away from fusee.
- 6. Light fusee by sharply scratching the igniter across the striker.
- 7. Strike fusee (away from body).
- 8. Apply flame to simulated fuel.
- 9. Extinguish fusee by striking sharply on ground or by placing lighted end in mineral soil.

FIREFIGHTER TRAINING, S-130
UNIT 7 - DRIP TORCH PERFORMANCE EVALUATION

The student will provide an oral response to the following questions. All questions and the performance evaluation are pass/fail.

1. Describe four hazards to operators when using a drip torch.

2. Describe the fuel mixture for a drip torch.

Performance evaluation:

Given a drip torch in proper working order, rags, matches, a cleared area and PPE, correctly demonstrate the proper procedures for (a) assembly, (b) lighting, carrying and spreading burning fuel, extinguishing, and (c) storing the drip torch.

CHECKLIST:

Score by placing a check mark in the box:

If a. and b. of the performance examination takes more than five minutes or if there is a failure on any step or procedure, this constitutes failure of the exam.

- a. Assemble the drip torch.
 - Shake fuel.
 - Unscrew locking ring.
 - Unscrew and secure fuel flow plug.
 - Remove spout and inspect gasket, fuel, and wick.
 - Set spout with wick in correct position and secure lock ring.
 - Open air vent.
 - Wipe off spilled fuel.

- b. Demonstrate proper procedure for lighting, carrying and spreading burning fuel, and extinguishing of the drip torch.
 - Spread fuel on ground litter or paper.
 - Ignite fuel.
 - Ignite drip torch from ground fire.
 - Demonstrate proper procedure for carrying and spreading burning fuel.
 - Extinguish wick by setting upright and letting wick burn dry.

- c. Storage procedures
 - Let wick cool before storage.
 - Return drip torch to condition of readiness.

FIREFIGHTER TRAINING, S-130
UNIT 7 - BURNOUT PERFORMANCE EVALUATION

The student will provide an oral response to the following question. The question and performance evaluation are pass/fail.

Describe two field expedient methods for igniting wildland fuels.

Performance evaluation:

Given a cleared area, PPE, and materials necessary for a field expedient method of igniting wildland fuels, correctly demonstrate or simulate the proper procedures for igniting a field expedient device and ensure that all safety considerations are met.

- Ignite field expedient device.
- Demonstrate proper procedure for spreading burning fuel.
- Extinguish properly.
- Ensure all safety considerations are met.

FIREFIGHTER TRAINING, S-130

Unit 8 - Use of Water

OBJECTIVES: Upon completion of this unit, students will be able to:

1. Given a backpack pump and a source of water, demonstrate how to properly operate and maintain the pump.
2. Correctly identify common hose components and accessories.
3. Describe the process of correctly unrolling hose.
4. Use a hose clamp and/or field-expedient method to restrict water flow in a charged line.
5. Describe and demonstrate the two hose lay methods.
6. Correctly identify the water use hand signals.
7. Demonstrate the nozzle settings for straight stream and fog spray.
8. Describe a fire situation when the straight and fog spray nozzle water streams would be used.
9. Describe three protective measures for hose and fittings when in use or being transported.
10. Describe four hazards to hose lays.
11. Retrieve deployed hose using two methods; i.e., watermelon roll, firefighters' carry, figure 8.
12. Identify and mark non-serviceable sections of hose and couplings.

I. BACKPACK PUMP

- A. Introduction
- B. Terminology/Parts
- C. Use
- D. Care and Maintenance
- E. Safety

II. WATER DELIVERY SYSTEMS

- A. Introduction
- B. Components and Accessories
 - 1. Fittings and Connections
 - 2. Nozzles
 - 3. Hose
 - 4. Accessories

5. Safety equipment

III. UNROLLING HOSE

IV. RESTRICTING WATER FLOW

V. DELIVERY SYSTEMS

A. Hose Lay

B. Simple hose lay

C. Progressive hose lay

VI. HAND SIGNALS

VII. WATER PATTERNS

A. Straight Stream

B. Fog/spray

- C. Application

VIII. CARE OF HOSE, FITTINGS, AND ACCESSORIES

- A. Roll hose to protect exposed threads.
- B. Replace protective caps on accessories and male hose ends.
- C. Be sure female ends have correct gasket size.
- D. Drain water from hose.
- E. Use accepted method of rolling hose when retrieving, e.g., watermelon roll, figure eight.
- F. Hazards to Hose and Accessories
- G. Defective Hose and Accessories

IX. EVALUATION

**FIREFIGHTER TRAINING, S-130
BACKPACK PUMP
PERFORMANCE EVALUATION**

Performance evaluation:

Demonstrate the proper way to operate and maintain a backpack pump.

CHECKLIST:

Score by placing a check mark in the box. Failure on any step or procedure constitutes failure of the exam.

- 1. Fill with clean or strained water.
- 2. Maintain proper footing and stance.
- 3. Maintain proper body position for carrying and lifting.
- 4. Use both straight stream and fog spray.
- 5. Directs stream properly.
- 6. Clear clogged nozzle, if clogged.
- 7. Clean quick connect, if dirty.

**FIREFIGHTER TRAINING, S-130
USE OF HOSE AND WATER
PERFORMANCE EVALUATION**

Performance evaluation:

Demonstrate correct methods and techniques of the use of hose and water.

CHECKLIST:

Score by placing a check mark in the box. Failure on any step or procedure constitutes failure of the exam.

- 1. Utilize proper hand signals.
- 2. Identify commonly used fittings and hose.
- 3. Set up hose lays and identify hazards to those hose lays.
- 4. Restrict water flow by the use of hose clamp or field-expedient method (charged line).
- 5. Utilize various nozzle settings.
- 6. Utilize proper water application.
- 7. Perform hose retrieval.

FIREFIGHTER TRAINING, S-130

Unit 9 - Suppression

OBJECTIVES: Upon completion of this unit, students will be able to:

1. Describe three methods for breaking the fire triangle.
2. Describe three methods of attack on a fire.
3. List three suppression techniques and describe their uses.
4. Describe the blackline concept.
5. Describe four kinds of fire control line.
6. Name four threats/hazards to an existing control line when fire is burning inside the line.
7. Describe the proper follow-up procedures for a dozer or tractor plow fireline.
8. Describe two kinds of coordinated crew techniques used for fireline construction and with at least four additional personnel, construct a fireline utilizing these techniques.
9. Describe safety procedures to follow when in an area where retardant/water drops are being made.
10. Describe five safety procedures to follow when working around engines, tractor plows, and dozers.
11. Demonstrate the proper use of appropriate hand tools during fire suppression activities.
12. Demonstrate the construction of a cup trench on a steep slope.

I. INTRODUCTION

- Control Line: Comprehensive term used for all the constructed or natural fire barriers and treated fire edges used to control the fire.
- Fireline: Any cleared strip or portion of a control line from which flammable material has been removed by scraping or digging down to mineral soil.

II. THE FIRE TRIANGLE AND FIRELINE CONSTRUCTION STANDARDS

A. Elements of the Fire Triangle

1. Oxygen - in the air
2. Heat - a source of ignition
3. Fuel - any combustible materials

B. Methods for Breaking the Fire Triangle

1. Oxygen - Suffocate the fire with dirt or water to rob the fire of oxygen.
2. Heat - Cool the fire by applying water, dirt, retardant or a combination.
3. Fuel - Separate the fuel to prevent combustion or remove fuel during fireline construction.

C. Fireline Construction Standards

Some factors that likely will influence standards for line construction are:

1. Fuel type of the area
2. Fuel moisture
3. Continuity and arrangement of fuels
4. Temperatures will inversely affect fuel moisture
5. Increases in wind

III. METHODS OF ATTACK

A. Direct Attack

B. Indirect Attack

C. Flanking/Parallel Attack

IV. SUPPRESSION TECHNIQUES AND USES

A. Hotspotting

B. Cold Trailing

C. Scratch Line

D. Fireproofing Fuels

E. Burning Out

V. BLACKLINE CONCEPT

VI. TYPES OF FIRE CONTROL LINE (TO MINERAL SOIL,
PERMAFROST, OR WATER LEVEL)

A. Constructed Fireline

B. Natural Control Line

VII. THREATS TO EXISTING CONTROL LINE

A. Spotting

B. Rolling Debris

C. Creeping

D. Radiant Heat

VIII. DOZER OR TRACTOR PLOW FIRELINE FOLLOW UP PROCEDURES

A. Clean Up

B. Break Up Machine Piles and Berms

C. Fireproof Needed Areas

D. Prepare and Burn Out Control Line

E. Security of the Control Line

F. Mop up the Interior

G. Patrol the Control Line

IX. TYPES OF COORDINATED CREW TECHNIQUES

A. One-lick (Progressive)

B. Bump-up (Leap frog)

X. RETARDANT/WATER DROP SAFETY PROCEDURES

A. Retardants and water are useful tools in the suppression of wildfire, but can be dangerous to personnel working in the drop area. Retardants will reduce the rate of spread but rarely extinguish a fire. An airplane traveling at 130 knots and dropping 2,000 gallons (as much as 10 pounds per gallon) can do a lot of damage to the drop area.

B. If you have prior information that there will be a drop in your area:

1. Indicate your presence (usually a supervisor responsibility).
2. Move out of the area. At least 200 feet perpendicular to the drop.
3. Remain clear of large old trees, snags, etc. Maintain a distance $1\frac{1}{2}$ times the height of the nearest tree.

4. Determine when drops are completed.
5. Move back into the area quickly to take advantage of the retardant/water effects on the fire.
6. Remember that the area may be slick after retardant drop.

C. Bodily injuries can be caused by low drops in the following examples:

1. Being thrown against rocks, trees, etc.
2. Being struck by flying debris knocked out of trees by the retardant.
3. Being struck by tools or debris kicked up by the retardant.

D. If you are unable to move clear of the drop area, follow accepted agency procedures for protecting yourself and others.

XI. SAFETY PROCEDURES USED AROUND FIRELINE EQUIPMENT

A. Engines

B. Tractor Plow and Dozer

XII. APPLICATION/EVALUATION

- A. Demonstrate the proper use of appropriate hand tools during suppression activities (line construction, hot spotting, mopup).

- B. Construct a control line using at least two coordinated crew techniques.

- C. Demonstrate the construction of a control line with a cup trench on a steep slope.

- D. Demonstrate the proper procedures to follow when caught in a retardant/water drop.

FIREFIGHTER TRAINING, S-130
UNIT 9 - SUPPRESSION
PERFORMANCE EVALUATION

Performance evaluation:

INSTRUCTOR CHECKLISTS:

Score by placing a check mark in the box. Failure on any step or procedure constitutes failure of the exam.

1. Demonstrate the proper use of appropriate hand tools during suppression activities (line construction, hot spotting, mopup).

a. Inspect tool.

b. Safe use of hand tool.

2. Construct a control line using at least two coordinated crew techniques.

a. Proper spacing when walking and working (10 - 15 feet apart).

b. Line extending to mineral soil, water level, or permafrost.

c. Proper intra-crew communications.

d. Proper use of crew for specified method.

3. Demonstrate the construction of a control line with a cup trench on a steep slope.

- a. Adequate downhill berm.
- b. Appropriate tool choice.
- c. Adherence to safety procedures.
- d. Cup trench can withstand a rolling firebrand representative of the area; e.g., rolling pine cones, pieces of wood, logs, palmetto, cacti, nuts.

4. Demonstrate the proper procedures to follow when caught in a retardant/water drop.

In some instances, it may not be possible to complete evaluation of situation #4. However, the instructor should ensure that students have a thorough understanding of these techniques and their local variations.

Contingency:

Student will describe each method and local variation of each. May be done orally or in writing. Instructor evaluates students to ensure they meet the objective.

- a. Wear full PPE.
- b. Lie face down, head toward direction of incoming aircraft.
- c. Helmet on securely with chin strap, feet spread, goggles in place.
- d. Hand tool held firmly at side.
- e. Grab something solid such as a rock, tree or shrub.
- f. Move out of area.

FIREFIGHTER TRAINING, S-130
UNIT 9 - SUPPRESSION

UNIT 9 QUIZ
(50 Total Points)

A minimum score of 35 points is required for a passing grade.

1. Identify the three elements of the fire triangle. (3 points)

2. Name and describe two primary methods of attack on a fire. (6 points)

3. Explain when the following five suppression practices are used. (10 points)
 - a. Hotspotting

 - b. Cold trailing

 - c. Cup trench

 - d. Scratch line

 - e. Fireproofing

4. Describe the blacklining concept. (2 points)

FIREFIGHTER TRAINING, S-130

Unit 10 - Patrolling and Communication

Lesson A - Patrolling

OBJECTIVES: Upon completion of this lesson, students will be able to:

1. Describe five ways to communicate with designated personnel.
2. Describe a systematic method of locating spot fires.
3. Describe four considerations when patrolling a fire.

I. INTRODUCTION

As a member of a fire crew, you may be called upon to:

- A. Communicate any unusual situation to your supervisor.

- B. Patrol a section of line.

- C. Patrol for spots or spot fires outside the fireline.

II. MAINTAINING GOOD COMMUNICATION

A. Communication Methods

- 1.

- 2.

- 3.

- 4.

- 5.

- 6.

B. Identify a Communication Plan in Advance with Supervisor.

This may include:

1. What type of communication to use.
2. How often you must report.
3. What kind of information to report.
4. What types of signals to use if necessary.
5. Having a backup plan.

III. PATROLLING THE FIRE AREA

Considerations for patrolling an area or path include:

A. Purpose of the Patrol Assignment

1. To patrol constructed line looking for weak areas, hot spots, and slopovers.
2. To reinforce the line when necessary.
3. To patrol an area outside of the line looking for spot fires.

B. Coverage of the Assigned Area

1. This should be determined by your supervisor and the situation.
2. Is the area fairly hot or does it consist of a long cold section of line?
3. Does the assigned area need to be covered once every operational period or in any other emergency?
4. Do instructions tell how often the reports should be made and how to report to the supervisor in case help is needed or in case of an emergency?

C. Information to be Reported

1. The need for help in the patrol area.
2. The fire behavior.
3. Machinery in the area.
4. Any hazards.

D. Consider working in pairs or in a systematic approach.

E. Always know where safety zones are located and have planned escape routes.

IV. PATROLLING FOR SPOT FIRES

A. Conditions that May Contribute to Spot Fires:

1. Extremely dry weather
2. Steep topography
3. Heavy fuel
4. Crown fires
5. Whirlwinds or dust devils
6. Torched-out, lone tree
7. Wind across the fireline
8. Punky logs and tree roots hidden beneath the fire line in the soil
9. Snags
10. Flashy fuels

B. Searching for Spot Fires

1. Inspect an area adjacent to the fire determined by your supervisor.
2. Select two reference points in that area (such as trees).
3. Travel between the reference points in a pattern parallel to the fireline, systematically covering that area.
4. Patrol areas at intervals determined by fuel type.

C. If a Spot Fire is Found:

1. Report it to your supervisor.
2. Begin initial attack, and suppression.
3. Flag area of spot fire.
4. Flag to main fireline, if nearby.

V. APPLICATION

Given a marked area, the students will:

- A. Determine two reference points.

- B. Demonstrate method of search.

- C. Demonstrate or describe how a spot fire would be marked on the ground.

- D. Describe to whom spot fire would be reported.

VI. EVALUATION

FIREFIGHTER TRAINING, S-130
UNIT 10 - Patrolling

UNIT 10 QUIZ
(30 Total Points)

Passing score requires a minimum score of 21 points.

1. Describe four considerations when patrolling a fire. (8 points)
2. Describe five ways to communicate with designated personnel. (10 points).
3. Describe a systematic method of locating spot fires. (8 points)
4. Describe how spot fires are marked on the ground. (4 points)

FIREFIGHTER TRAINING, S-130

Unit 10 - Patrolling and Communication

Lesson B - Radio Communication

OBJECTIVES: Upon completion of this lesson, students will be able to:

1. Describe frequencies and how they affect radio communications.
2. List four elements of proper radio use procedures.
3. Transmit a message clearly using proper procedure and language.
4. Describe three radio trouble shooting practices used to improve radio reception or transmission.
5. Describe precautions and care to protect the radio from damage.

I. INTRODUCTION

Radio classes:

A. Lowband

1. Utilizes low frequency range.
2. Travels greater distances.
3. Waves are more able to bend around mountains, etc.
4. Used widely in the 1960s, 70s, and 80s.

B. Very High Frequency (VHF)/Highband

1. Utilizes upper end of the (FM) range.
2. Operates from 150-170 frequency range.
3. Waves travel shorter distance than lowband.
4. Needs repeater to increase range.
5. Used frequently in wildland fire operations.

- C. Ultra High Frequency (UHF)
 - 1. Utilizes the next higher frequency band above VHF/highband.
 - 2. Radio waves travel distance is short because waves absorbed by vegetative cover, trees, etc.
 - 3. Used primarily around fire base camp for the logistics section.

II. TERMINOLOGY

- A. Programmable, Hand Carried Radio
- B. Mobile Radio - in Vehicle
- C. Base Station Radio - Permanent Location
- D. Antenna
- E. Microphone
- F. On-off Switch
- G. Volume Control
- H. Squelch Control

- I. Channel Selector
- J. Tone control
- K. Scanner
- L. Replacement Batteries and Installation

III. RADIO USE

- A. For Official Use Only.
- B. Emergency Traffic has Priority.
- C. Use Clear Text to Relay Message. No “CB” Talk.
- D. Think Before Pushing the Button.
- E. Write Down Messages you Receive.

IV. PROPER RADIO USE PROCEDURES

- A. Be Courteous.
- B. Swearing and Obscene Language is Prohibited.

- C. Answer Radio Calls Promptly.
- D. Have Pencil and Note Pad Ready for Messages.

E. Be Brief; Radio Channels are Busy.

F. To Declare an Emergency:

Break into the radio traffic and ask for the channel to be cleared for emergency traffic.

G. Talk Into the Microphone.

H. Use Normal Tone of Voice.

V. TRANSMITTING AND RECEIVING A RADIO MESSAGE

The proper procedure in transmitting a message is as follows:

- A. Wait until the person using the radio is finished before you start.
- B. When initiating a call, transmit the station name or unit number of the person you are calling first, followed by your station name or unit number.
- C. Microphones should be held 2-4 inches away from your mouth; avoid wind blowing into microphone when speaking.

- D. Wait one full second after pressing the transmit button before speaking.
- E. Answer the radio with your station name or unit number.
- F. If more than one station or unit calls at the same time, use the procedure for initiating a call to identify who needs to answer.
- G. The person who initiates the call closes with the proper identifier.

VI. RADIO TROUBLESHOOTING

- A. Radio Traffic Overloaded
- B. Poor Location
- C. Low Battery
- D. Loose Antenna
- E. Operating on Wrong Channel

VII. RADIO CARE AND MAINTENANCE

- A. Protect the radios from dust, moisture, fire retardant, excessive vibration, dropping, extreme heat, etc.
- B. Keep portables in a protective case.
- C. Do not modify or attempt repairs on any radios. Notify your supervisor or a qualified radio technician so the problem can be fixed.
- D. Do not use the antenna to pull the portable radio from its case.

VIII. APPLICATION/EVALUATION

FIREFIGHTER TRAINING, S-130
UNIT 10, LESSON B - RADIO COMMUNICATIONS
PERFORMANCE EVALUATION

Performance evaluation:

INSTRUCTOR CHECKLISTS:

Score by placing a check mark in the box. Failure on any step or procedure constitutes failure of the exam.

1. Given a two-way portable radio, demonstrate how to prepare, transmit and receive.

To prepare portable for use:

- a. Check antenna.
- b. Turn on radio.
- c. Adjust squelch: turn knob to the point of garbled noise, then turn back until radio is quiet.
- d. Select channel to be used.

To transmit:

- a. Depress microphone key.
- b. Place microphone two to four inches from mouth.
- c. Speak distinctly and concisely.
- d. Release microphone key.

To receive:

- a. Turn radio on.
- b. Adjust volume to hear communication.
- c. Listen.

2. Given a two-way mobile radio, demonstrate how to prepare, transmit and receive.

To transmit:

- a. Turn on engine in vehicle.
- b. Turn on radio; adjust volume.
- c. Adjust squelch.
- c. Select channel.

To receive:

- a. Turn on; adjust volume.
- b. Adjust squelch.

3. Transmit a message clearly using proper procedure and language.

- Messages should be transmitted in normal, concise language in 30 seconds or less.

THE FOLLOWING TWO TASKS MAY NOT BE OBSERVABLE. IF NOT, THE STUDENT MAY ANSWER ORALLY OR IN WRITING.

4. Demonstrate what to do to improve radio reception and/or transmission.

5. Demonstrate precautions needed to protect the radio from damage.

FIREFIGHTER TRAINING, S-130

Unit 11- Mopup and Securing the Fireline

OBJECTIVES: Upon completion of this unit, students will be able to:

1. Describe and demonstrate how to extinguish burning materials by chopping, scraping, and mixing them with soil and water.
2. Describe precautions to take when applying water to hot materials and demonstrate proper techniques for doing so.
3. Describe a systematic method of mopup and give two reasons for using this method.
4. Describe how each of the four senses aid in detecting burning materials.
5. Discuss the importance of breaking up and dispersing machine piles and berms adjacent to the control line.
6. Demonstrate the technique of cold trailing on a simulated fire perimeter.
7. State three factors that determine the amount of additional work required for a water or retardant line.
8. Given a constructed control line, strengthen the line to facilitate holding by rearranging and fireproofing fuels adjacent to the line.

I. INTRODUCTION

II. MINIMUM IMPACT SUPPRESSION TACTICS

III. METHODS OF MOPUP

Hand tools are used for mopup in the following ways:

- Scraping
- Digging
- Stirring
- Mixing
- Separating
- Turning logs and other heavy materials

A. Dry Mopup

B. Wet Mopup

C. Safety

IV. SYSTEMATIC MOPUP

Process for applying systematic mopup:

- Start with the hottest area and progress to the coolest.
- Plan a beginning and an ending point. Keep to the plan and work methodically.
- Work inward from the control line.
- Examine the entire assigned area.
- Make sure instructions are clear. Ask questions.
- For large burns and/or complicated situations some type of grid (block) system should be implemented. Set priorities and number each block.

V. USING THE FOUR SENSES TO DETECT HOT MATERIALS

A. Sight - look for:

1. Smoke
2. Heat waves
3. White ash
4. Stump holes

5. Steam

6. Gnats

B. Touch

1. Do not wear gloves.

2. At first, feel with the back of your hand about 1 inch away, then carefully with direct contact.

C. Smell

1. Smoke

2. Burning materials and the gases that these materials give off

D. Hearing - listen for the:

1. Crack and pop of burning material.

2. Hiss of water as it hits hot materials.

VI. COVERED FUELS

A. Machine Piles

B. Ground Fuels

VII. OTHER AIDS TO ASSIST THE MOPUP PROCEDURE

- A. Infrared Imagery – Aircraft

- B. Infrared Devices (heat detectors) – Handheld

VIII. STRENGTHENING THE CONTROL LINE

- A. Rearranging Fuels

- B. Trenches

- C. Waterbars

IX. FOLLOW UP OF A WET LINE, RETARDANT LINE, OR TREATED AREA

- A. Deficiencies that may occur
 - 1. Not all fuels in a treated area may be coated.
 - 2. Skips in application of water or retardant occur.
 - 3. Evaporation has dried out fuels since application.

B. Action

1. Assess the nature of the fuels inside and outside the treated area for:
 - Arrangement
 - Continuity
 - Compactness
 - Loading

2. Assess the fire activity threatening the treated area for:
 - Smoldering
 - Creeping
 - Running
 - Spotting
 - Crowning

3. Assess the chances for later burn through the treated area. Look for:
 - a. Parched and/or scorched but unburned fuels near the area.
 - b. Fuels not fully burned out near the treated area.

4. Reinforce the treated area by:
 - a. Constructing a fireline.

- b. Limbing up nearby trees and brush.
 - c. Fireproofing fuels on the outside of the control line.
 - d. Dropping snags.
5. If safe and practical, burn out areas of unburned fuel near the treated area to prevent a possible slopover or reburn later.

X. APPLICATION/EVALUATION

A. Dry Mopup

B. Wet Mopup

Types of Class A Foam

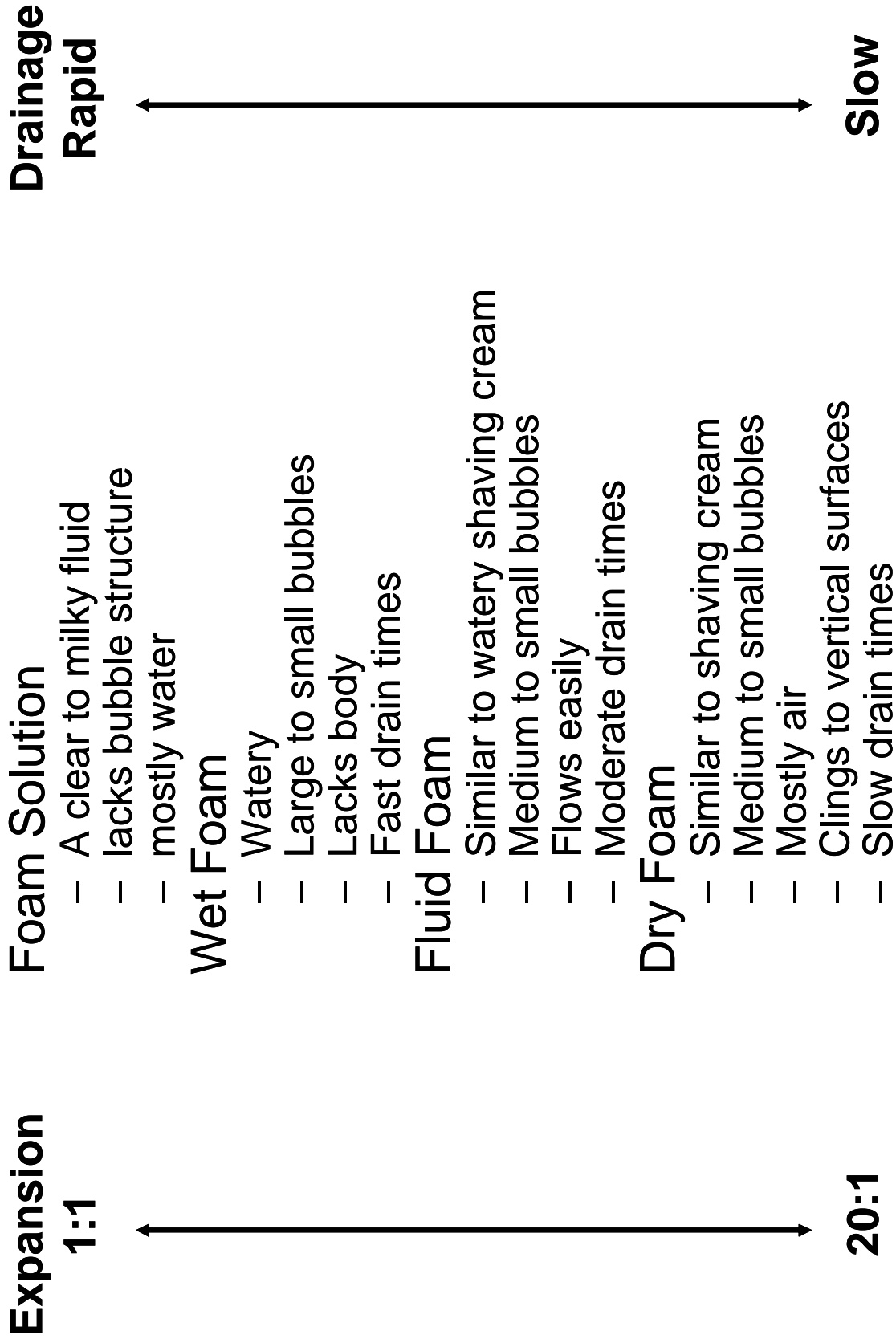

FIREFIGHTER TRAINING, S-130
UNIT 11 - MOPUP AND SECURING THE FIRELINE

UNIT 11 QUIZ
(65 Total Points)

A minimum score of 45 is required for a passing grade the written quiz.

1. Which four senses aid in the detection of burning materials? How? (12 points)

2. Describe five precautions or techniques used to safely apply water to hot materials. (10 points)

3. Why is it important to break up and disperse machine piles adjacent to the fireline? (3 points)

4. Describe a systematic method of mopup. (10 points)

5. Describe the technique of cold trailing on a simulated fire perimeter. (4 points)

6. Describe what to do when using the following two methods to strengthen the control line. (8 points)
 - a. Rearrange fuels adjacent to a control line to facilitate holding the fire.
 - b. Fireproof fuels adjacent to a control line to facilitate holding the line.
7. Describe the proper follow up procedures for a wet line, retardant line, or treated area. (10 points)
8. Describe the method to extinguish burning materials without the use of water. (4 points)
9. Describe the method for wet mopup. (4 points)

FIREFIGHTER TRAINING, S-130

Unit 12 - Fire Exercise

OBJECTIVES: Upon completion of this unit, when given a live fire or simulated (flag) fire exercise, the students will be able to:

1. Demonstrate proper travel procedures en route to and from a fire.
2. Demonstrate proper use, handling, and maintenance of handtools.
3. Construct progressive and leap frog handline.
4. Construct simple and progressive hoselays.
5. Use escape routes to promptly retreat to a safety zone.
6. Participate in an “after action review.”

FIREFIGHTER TRAINING, S-130

Unit 13 - Hazardous Material Awareness

OBJECTIVES: Upon completion of this unit, students will be able to:

1. Develop a working definition of hazardous materials.
2. Explain the general guidelines when reacting to a possible hazardous materials emergency.
3. List and explain the six steps in the D.E.C.I.D.E. process.
4. List and explain the six clues for detecting the presence of hazardous materials.

I. INTRODUCTION

A. Definition of Hazardous Material

B. Their Role in Our Lives

C. Exposure to Hazardous Material

1. In the event you encounter a hazardous material incident you must ask the following questions:
 - Am I properly trained to handle the situation?
 - Will my action create undue risk to myself or others?
 - Will my involvement favorably change the outcome?
2. Knowledge is necessary to protect fellow workers, yourself and the surrounding community and environment.
3. Ability to recognize and identify hazardous materials will help you become part of solutions, not part of the problem.
4. The problem must be analyzed. Set goals and objectives to minimize the potential harm associated with the release of hazardous materials.

II. GENERAL GUIDELINES WHEN REACTING TO A POSSIBLE HAZARDOUS MATERIALS EMERGENCY

A. Isolate or Deny Entry

B. Identify the Hazards

DOT Emergency Response Guidebook

- White pages - Basic placards/colors.
- Yellow pages - List hazardous materials by consecutive identification (ID) number.
- Blue pages - List hazardous materials alphabetically.
- Orange pages - Give specific information on the hazards associated with the identified chemical.
- Green pages - Identify evacuation distances and water reactive materials which produce toxic gases upon contact with water.

C. Approach Cautiously

D. Obtain Help

E. Decide on Site Entry

III. D.E.C.I.D.E.

A. Detect Hazardous Materials Present

B. Estimate Likely Harm

C. Choose Response Objective

D. Identify Action Options

E. Do Best Option

F. Evaluate Your Progress

IV. APPLICATION

Hazardous Material Placard



FIREFIGHTER TRAINING, S-130

Unit 14 - Wildland/Urban Interface Safety

OBJECTIVES: Upon completion of this unit, students will be able to:

1. Identify the wildland/urban interface watch out situations.
2. Identify personnel safety concerns in wildland/urban interface fires.

I. INTRODUCTION

Three categories of tactical plans in the interface:

A. Defensive Mode

B. Offensive Mode

C. Combined Mode

II. DISCUSSION OF THE WILDLAND/URBAN WATCH OUT SITUATIONS

A. Wooden Construction and Wood Shake Roofs

B. Poor Access and Narrow Congested One-Way Roads

C. Inadequate Water Supply

D. Natural Fuels 30 Feet or Closer to Structures

E. Extreme Fire Behavior

F. Strong Winds

G. Evacuation of Public (Panic)

I. Bridge Load Limits

III. WORKING AROUND POWER LINES

The following powerline safety issues are extremely important and must be adhered to:

- Beware of water or liquids pooled or running along the surface. Liquids are good conductors of electricity.
- Downed conductor (line) on vehicle: DON'T leave vehicle until power company arrives. If the vehicle is on fire or fire is near, jump clear, DON'T hang on, keep feet together and bunny hop away.
- DON'T operate heavy equipment under powerlines.
- DON'T use powerline rights-of-way as a jump or cargo drop spot.
- DON'T drive under powerlines with long antennas.
- DON'T fuel vehicles under powerlines.

- DON'T stand near powerlines during retardant or helicopter bucket drops.
- DON'T park under powerlines.
- DON'T apply straight stream to powerlines.
- DON'T go near or move downed lines.
- DON'T stand or work in dense smoke near power lines. The potential for arcing is high.

IV. HAZARDOUS MATERIAL

- A. Petroleum or Propane Tanks
- B. Garages and sheds can contain many of the following:
- C. Drug Labs (meth labs)
- D. Identify and mark all hazards with flagging or other warning devices. Post a lookout. Keep your supervisor informed of hazards. Avoid breathing hazardous fumes without proper protection at all costs.

V. SUMMARY

A. Structure Defense and Safety to Personnel and Equipment

B. Hopeless Situations

C. DOs and DON'Ts in Protecting Structures in the Interface

FIREFIGHTER TRAINING, S-130

Unit 15 - Pump Operations (Optional)

OBJECTIVES: Upon completion of this unit, students will be able to:

1. Identify the two common types of pumps.
2. Identify the responsibilities and personal protective equipment of the portable pump operator.
3. Demonstrate the proper setup and operation of a portable pump.

I. INTRODUCTION

II. TYPES OF PORTABLE PUMPS

There are two commonly used pumps for wildland fire suppression.

A. Positive Displacement Pumps

1. Rotary gear pump
2. Piston pump
3. Advantages
4. Disadvantages

B. Centrifugal Pump

1. Most commonly used pump in fire suppression.
2. Consists of one to four devices called impellers.
3. Advantages
4. Disadvantages

III. DELIVERY SYSTEM FOR PORTABLE PUMPS

A. Pacific Mark 3 Centrifugal Pump

1. Two cycle engine, air cooled, mixed gas $\frac{1}{2}$ pint per gallon. 16:1 ratio (unless specified otherwise by manufacturer guidelines.)
2. 4-stage centrifugal pump
3. Weight = 55 pounds; horse power = 8.5
4. Maintenance

B. Wajax-Pacific/Halprin™ Wildfire Mark 3 Pump

1. Commonly called a Mark 3 pump.
2. Efficient and unit designed to meet the requirements of all fire control techniques.
3. Performance range makes it possible to use the pump for filling tanks and suppressing forest fires.
4. Suitable for rural and municipal fire protection or wherever a large volume of water is needed.
5. Two-cycle, single cylinder, 8.5 hp, rotex air-cooled engine.

6. Fuel must be mixed with oil (covered in detail later in the course).
7. The starter cord and handle is a spring-loaded rewind unit. In case of a rewind failure, remove outer case, put the rope on the crankshaft pulley and start the engine.
8. Some pumps are equipped with a decompressor switch which releases pressure from the combustion chamber to make starting easier. Close it as soon as the engine starts to prevent damage to the engine.
9. Use stop switch to shut off the engine after a cool down period, or in an emergency. Hold down until the engine has completely stopped.
10. The air filter is located inside the metal shroud connecting to the carburetor.
11. The choke lever is a flip type that closes the butterfly in the carburetor for a richer fuel mixture when starting a cold engine.
12. The throttle control is labeled and should be set according to directions on the label.
13. The automatic cutoff switch stops the engine and eliminates overspeeding when the pump runs out of water or loses prime. The reset rod on the automatic cutoff switch may not work if the throttle is set half way, as the engine RPM may not be high enough to trip the reset.

14. The Mark 3 engine is coupled with a four-stage centrifugal pump.
15. The fuel tank holds five gallons of mixed fuel and attaches to the pump engine using a quick connect fitting.

IV. PACIFIC MARK 3 PUMP SUPPLEMENTAL INFORMATION

A. Pump Parts Identification

1. Starter
2. Muffler

B. Motor Protection

1. Equipped with an automatic cutoff switch that will stop the engine and prevent damage should overspeeding occur.
2. Conditions that could cause the unit to shut down include:
 - Pump not fully primed
 - Leaking suction hose connections
 - Defective suction hose
 - Loose cap on primer opening
 - Foot valve leaking or not completely submerged
 - Air locks in the suction hose

C. Ignition Checks

V. PUMP STORAGE, CARE, AND MAINTENANCE

A. Storage

B. Care and Maintenance

VI. ROLE OF THE PUMP OPERATOR

A. Safety

B. Pump Kit Components

C. Pump Site

VII. APPLICATION/EVALUATION

**FIREFIGHTER TRAINING, S-130
UNIT 15 - PUMP OPERATIONS
PERFORMANCE EVALUATION**

Performance evaluation:

Demonstrate the proper setup and operation of a portable pump.

INSTRUCTOR CHECKLIST:

Score by placing a check mark in the box. Failure on any step or procedure constitutes failure of the exam.

Pump Setup

- 1. Foot valve strainer assembly checked and attached to suction hose.
- 2. Suction hose and foot valve strainer assembly attached to suction end of pump.
- 3. Foot valve strainer assembly placed in water supply properly.
- 4. Pump primed (1 of 2 methods).
- 5. Fuel mixed in correct proportions.
- 6. Fuel system connections checked and cleaned.
- 7. Fuel hose attached to fuel can and pump.
- 8. Fuel supply valve opened.

- 9. Air vent on fuel can opened.
- 10. Correct fittings hooked on to discharge side of pump.
- 11. Discharge hose hooked to pump on discharge side.
- 12. Nozzle hooked up.
- 13. All connections on suction side of pump checked and tightened with proper tools.
- 14. Pump set near water source in a firm and level position.
- 15. Proper safety equipment used.
- 16. Needed tools and supplies readily available for use.
- 17. Check equipment.

Priming

- 1. First and preferred method
Attach the hand priming pump to the discharge side of the pump head. Water is drawn past the foot valve through the suction hose and into the pump case, filling all four cavities of the pump head. Some water will squirt from a small hole located on the handle end of the priming pump when the pump is primed.

OR

- 2. Second method
Remove the priming inlet cap on top of the pump case and pour water directly into the pump head. When the pump case is full, shake the suction hose to clear the hose of air. Add more water until pump case is full, replace inlet cap and tighten.

OR

- 3. Third method
Remove the priming inlet cap and take hold of the suction hose working it back and forth in the water source with quick jabbing motions. This will force water past the foot valve and into the pump head. When water flows out of the priming port, replace and tighten the pumping cap.

Starting

- 1. Fuel tank positioned near pump.
- 2. Pull the decompressor switch out until it comes to a “click” stop. Model year 1983 and newer models of Mark 3 pumps are equipped with the decompressor switch.
- 3. Close the choke shutter if the engine is cold.
- 4. Move the throttle lever to the “start and warm up” position.
- 5. Check the reset rod on the automatic cutout switch; it should be pushed in.
- 6. Pull the starter cord with short smooth pulls; do not fully extend the cord.

7. Push the decompressor switch fully in as soon as the engine starts.

8. Open the choke slowly after the engine has started.

Operation

1. Allow the engine to warm up for at least two minutes before using full throttle. Failure to do so may lead to piston scuffing and more serious damage.

2. Check the spark plug for cleanliness and check fuel mixture ratio. Do not perform any field adjustment on the carburetor. These adjustments are made in a shop under specific pump pressure.

3. Connections on suction side of pump checked for leaks.

4. Foot valve strainer assembly checked for proper placement.

Shutdown (Failure to use proper warm-up and cool-down procedures will result in severe engine damage.)

1. First method

a. Move the throttle lever to the “stop” position.

b. Allow the unit to run for approximately one minute with the throttle in this position.

c. Press and hold the stop switch until the engine is fully stopped.

2. Second method (Used when the pump is left in place and not expected to operate for several hours.)

a. Move the throttle to the “stop” position.

b. Older model fuel tanks - the fuel supply valve located in the recess of the tank is turned off.

Newer model fuel tanks - pull the male end of the fuel line quick-connect from the base of the tank.

The engine will run at a low idle and have ample time to cool down and will stop due to the lack of fuel.

FIREFIGHTER TRAINING, S-130

Unit 16 - Map Reading and Use of the Compass (Optional)

- OBJECTIVES: Upon completion of this unit, students will be able to:
1. Identify the symbols depicted on a locally used map with legend.
 2. Name and describe the land survey system used locally.
 3. Locate a legal description of a point on a map.
 4. Identify major topographic features, both in the field and on a map.
 5. Demonstrate the ability to read and shoot an azimuth (bearing) off a compass.
 6. Explain the importance of knowing the proper declination of an area.
 7. Determine one's walking pace on flat and sloped ground in one chain and 100 foot intervals.
 8. Given a compass with proper declination and a local map, determine an azimuth, distance, and be able to navigate through wildland terrain between two points.

I. INTRODUCTION

II. TYPES OF MAPS

- A. Highway Map
- B. Aeronautical Chart
- C. Military Map
- D. USGS Topographic Map
- E. Geographical Information System (GIS) Maps

III. FEATURES OF TOPOGRAPHIC MAPS

- A. General Information
 - 1. North arrow is normally pointed towards the top of the map.
 - 2. Map scale is usually found at the bottom of the map. One unit on the map represents a certain number of units on the ground, i.e., 1:24,000 reads as: one inch on the map equals 24,000 inches on the ground; or one inch on the map equals 2,000 feet on the ground.
 - 3. Quad size is usually found at the upper right corner of the map. This indicates how many minutes of latitude are contained within a particular map. Common map quads are 7-1/2 and 15 minutes. Map scale for 7-1/2 minute quads is normally 1:24,000, scale for 15 minute quads is normally 1:62,500.

4. Declination is usually found at the bottom of the map.
5. Contour interval is usually found at the bottom of the map.
6. Map name is usually found at the bottom right of the map.
7. Road classification is usually found at the bottom right of the map.
8. Colors - (reminder: most maps you get on fires are black and white)
9. Various scales are located around the perimeter of the map representing latitude/longitude, UTM, etc.
10. Map symbols show detail of landscape in the following areas:
 - Human-made features - city limits, political boundaries, roads, structures, orchards, surveying benchmarks, microwave towers
 - Water features - lakes, streams, oceans, intermittent streams
 - Vegetation features - forest, brush
 - Elevation features

B. Contour Lines

Actual lines on a map along which every point is at the same height above sea level.

C. Properties of Contour Lines

IV. LAND SURVEY SYSTEMS

- A. Metes and Bounds System
- B. Public Land Survey System
- C. Other Methods to Describe Map Locations
 - 1. Latitude and longitude
 - 2. Local map grid system
 - 3. Military grid
 - 4. Universal Traverse Mercator grid

V. METHODS FOR IDENTIFYING AND DESCRIBING LOCATIONS ON MAPS

- A. Local Grid System Method
- B. Latitude and Longitude

Measured in degrees, minutes and seconds.
- C. Township and Range from the Public Land Survey System
 - 1. Initial point: Most states west of the Mississippi and north of the Ohio Rivers were surveyed after the 1796 Public Land Survey law. Thirty-five initial points were established by astronomical observations.

2. Baseline: Extends east and west through each initial point.
3. Principal Meridian: Extends north and south through each initial point.
4. Township subdivision: Land is divided into “townships” by “range lines” running north-south (equivalent to longitude) and “township lines” running east-west (equivalent to latitude, note the difference between “township lines” and “townships”).
5. Sections: Townships are divided into 36 equally numbered “sections.” Sections are always numbered in the sequence depicted in the SW.
6. Section subdivision: sections can be divided into “quarter sections” which equal 160 acres and measure 40 chains on each side. These are referred to their location in relation to the middle of the section. Example: NW1/4.
7. A location is identified by township, range, section, and quarter section information. Example: NW1/4, S6, T3S, R12E.

VI. APPLICATION

VII. COMPASS INTRODUCTION

VIII. PARTS OF THE COMPASS

- A. Travel arrow: located at the top of the compass and indicates direction of travel on the ground (note luminous point).
- B. Various scales: located on the top and the sides of the compass and normally correspond with typical topographic map scales.

- C. Magnifying glass: located just below the travel arrow.

- D. Dial: revolving housing which is divided into 360 degrees. The dial rim is marked with the four cardinal directions, north, east, south, and west. Each mark represents two degrees, every 20th degree is marked with a number from 20 to 360. Zero and 360 degrees are the same.

- E. Index pointer: white mark on the dial where the bearing is read. Corresponds to the travel arrow.

- F. Magnetic needle: free swinging suspended needle located inside the dial. Red side always points toward magnetic north (note luminous point).

- G. Orienting arrow: located inside the dial and always points toward north on the dial as the housing is revolved (note luminous points). Will point toward the degree of declination if declination can be adjusted.

- H. Orienting lines: located inside the dial and are parallel to the orienting arrow.

- I. Aid lines: located above the dial on each side of the magnifying glass and are parallel to the travel arrow.

- J. Declination scale: located inside the dial and denotes magnetic declination from true north.

IX. DETERMINING AN AZIMUTH

Azimuths (also called bearings) are horizontal angles fixing a direction in respect to north, and are expressed in degrees.

- A. Cardinal Directions
- B. Reading an Azimuth
- C. Shooting an Azimuth/bearing (example 140 degrees)
- D. Determining Back Azimuth

X. DECLINATION (ALSO CALLED VARIATION)

- A. True North versus Magnetic North
- B. Setting Declination on a Compass
- C. Compare True and Magnetic North Azimuths on the Compass

XI. USING A COMPASS WITH A MAP

- A. Orienting a Map Toward North
- B. Shooting an Azimuth on a Map

XII. APPLICATION

XIII. FIELD EVALUATION

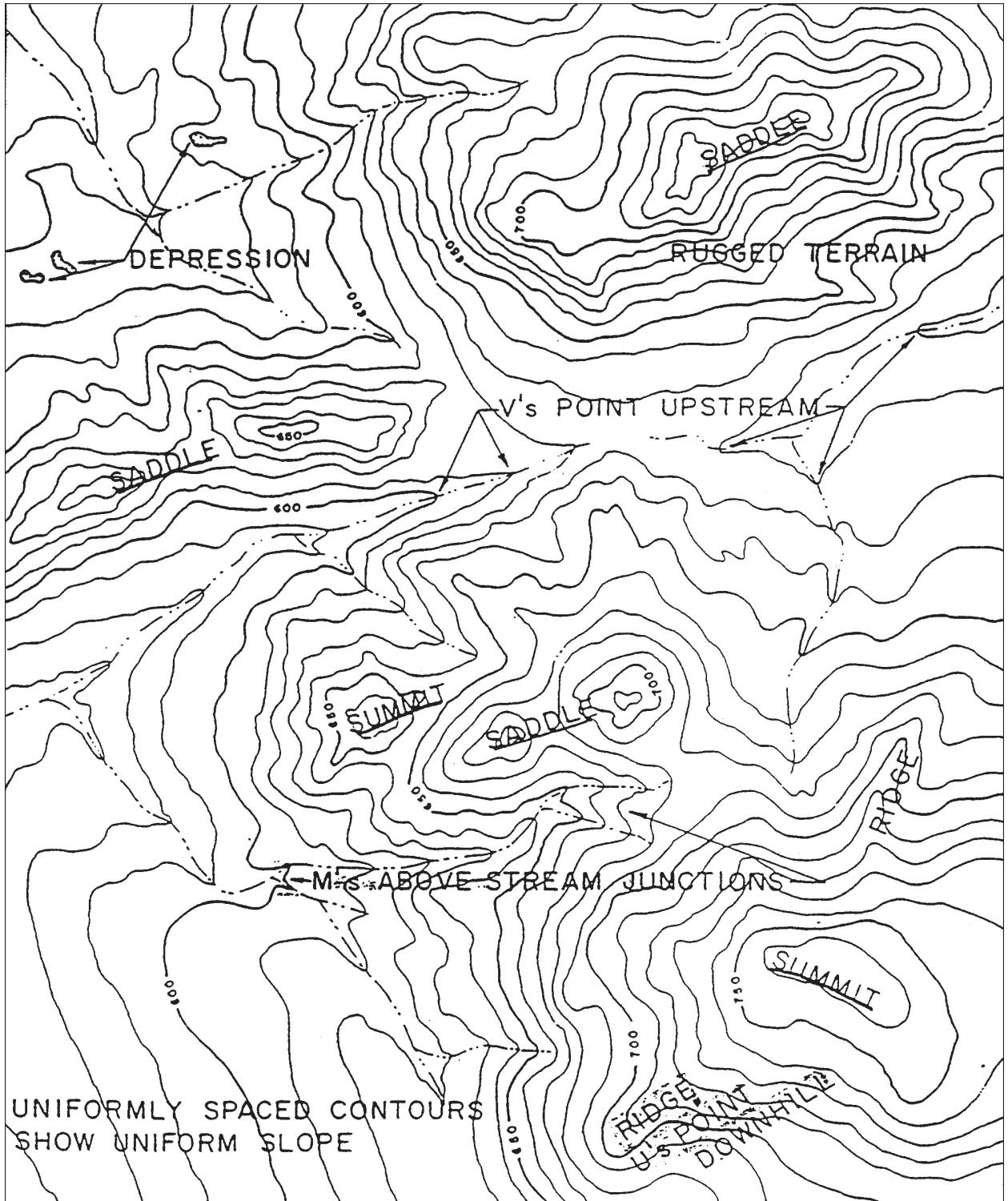

Match the profile (A-F) with the contour lines (1-6)



1

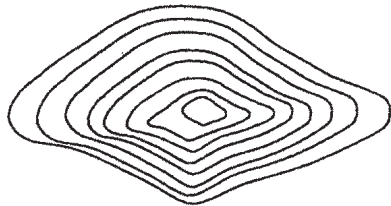

2

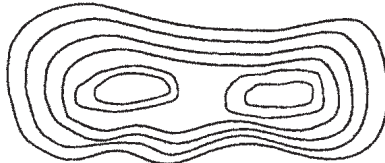

3

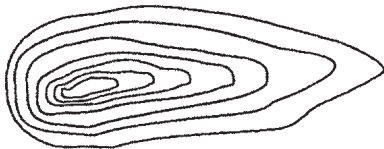

4

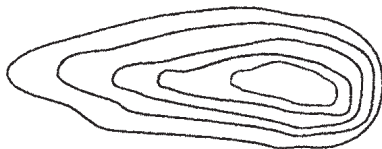

5

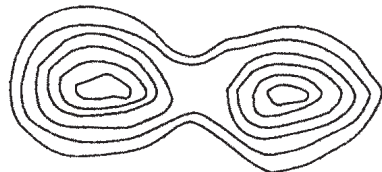

6



A



B



C



D



E



F

1. _____

2. _____

3. _____

4. _____

5. _____

6. _____

Latitude and Longitude

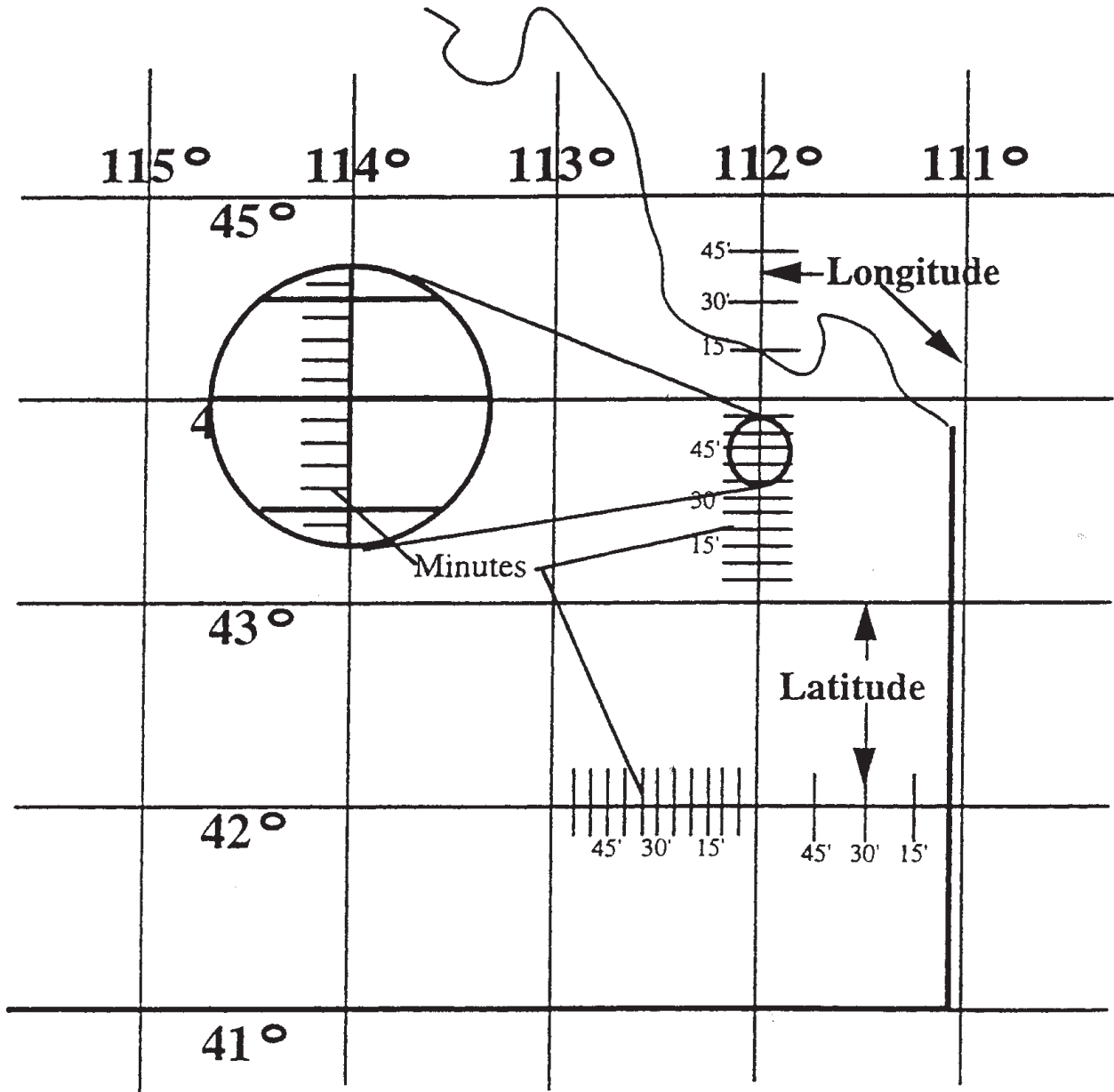

Township and Range Reference

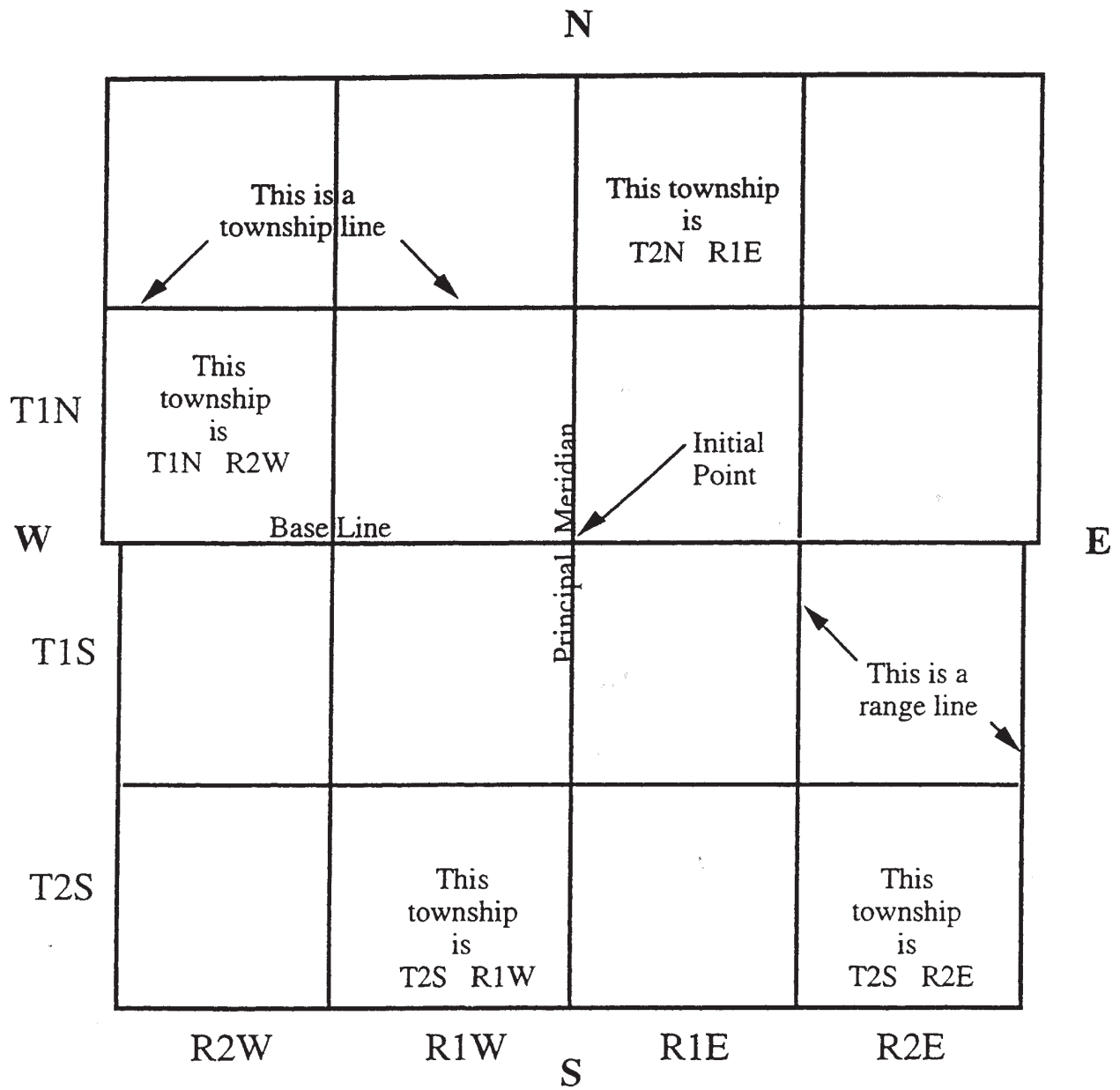

Numbering Sections Within A Township

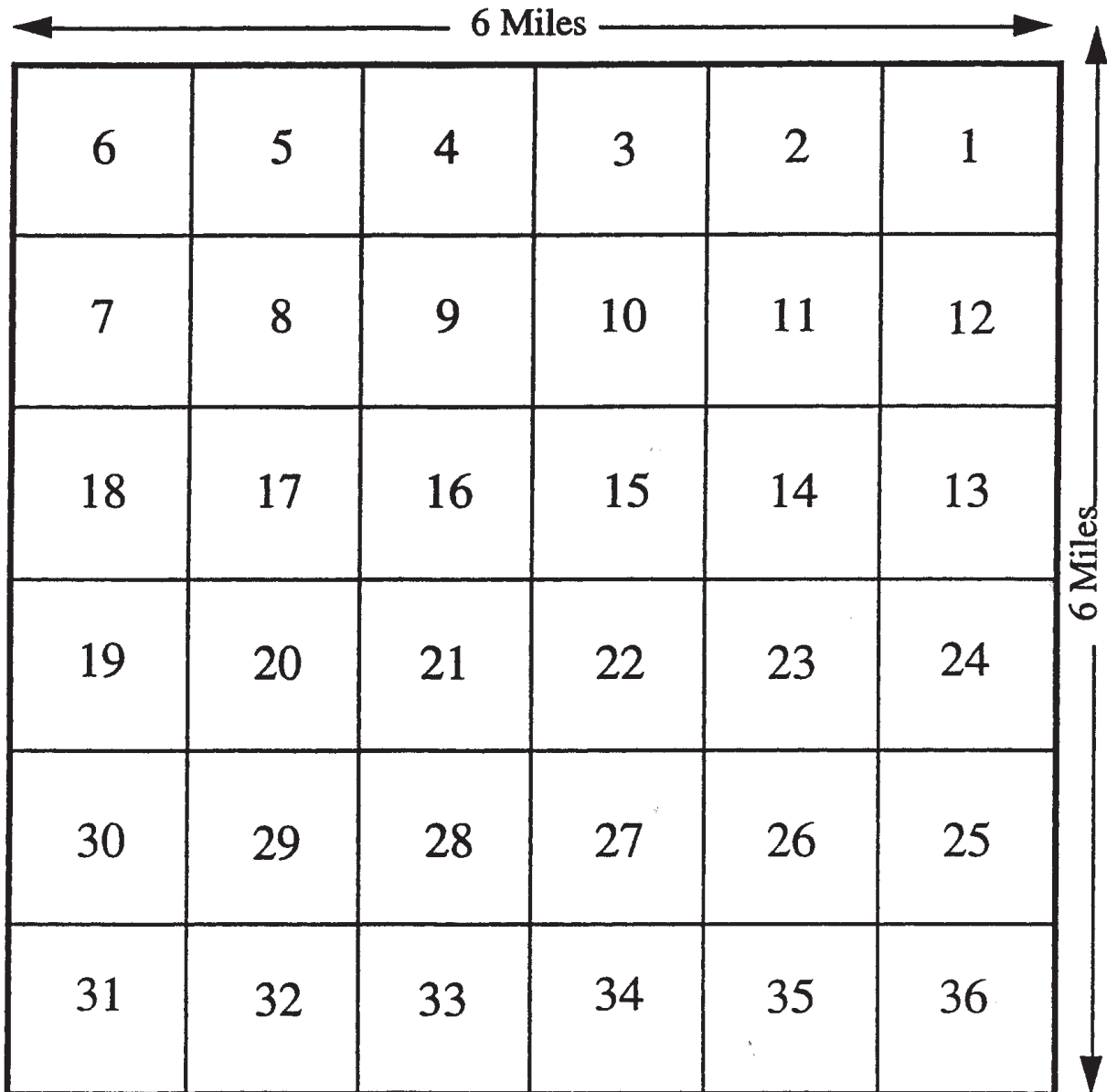

Numbering Sections Within A Township

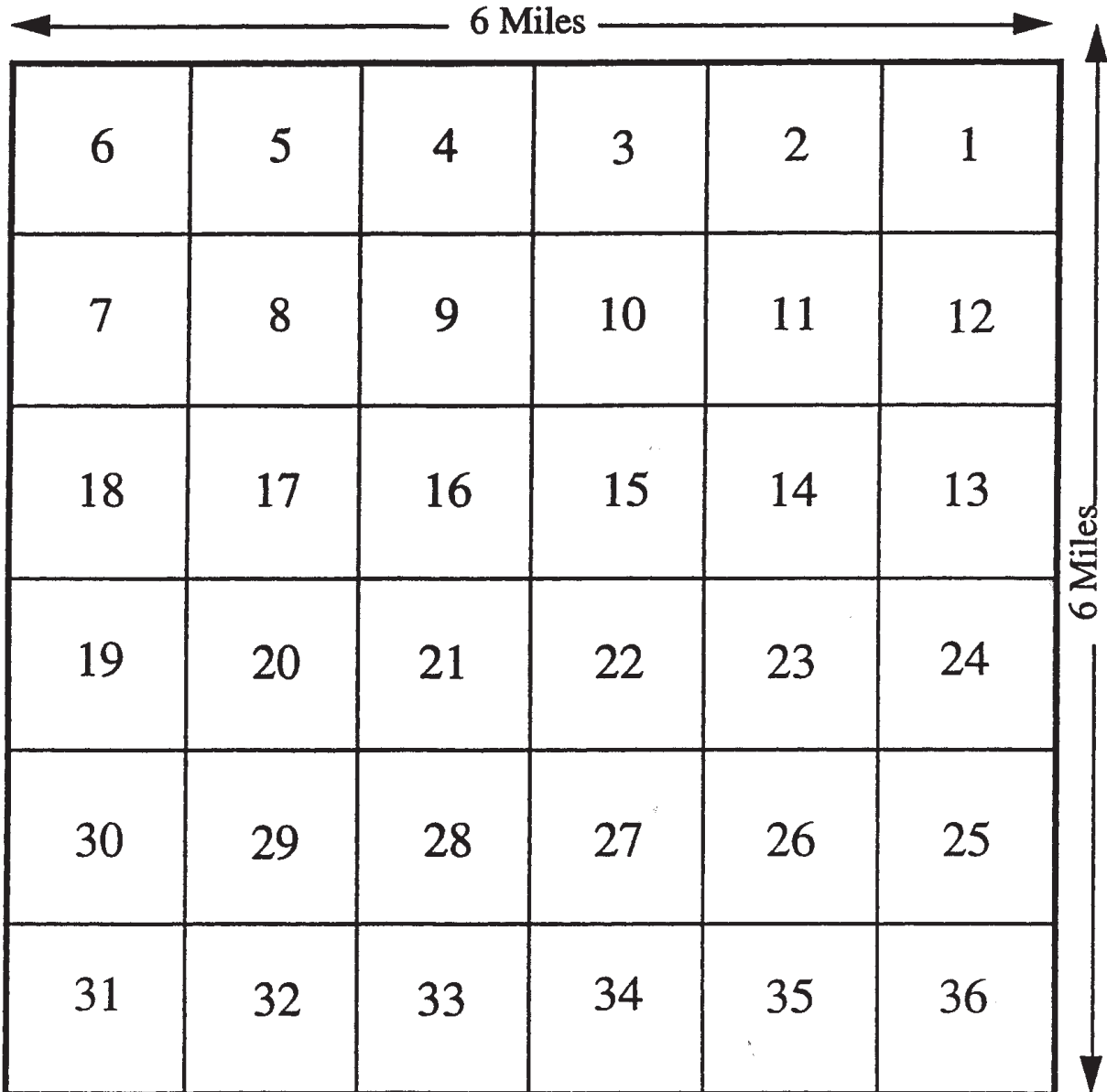

FIREFIGHTER TRAINING, S-130

Unit 17 - Wildland Fire Investigation (Optional)

OBJECTIVES: Upon completion of this unit, students will be able to:

1. Describe items to watch for when traveling to, arriving at, and during initial attack that might show the origin and/or cause of the fire.
2. Given a simulated situation, record and report all information that will help in determining fire cause and origin.
3. Given a simulated fire situation, designate and protect the area of fire origin.

I. INTRODUCTION

II. FIRE OBSERVATION AND ORIGIN AREA PROTECTION RESPONSIBILITIES

A. Observe

1. While traveling to the fire notice:

- Vehicles speeding away from the fire area.
- (If after dark) a vehicle without lights.
- Vehicles parked in unlikely spots.
- Children leaving the fire area.
- Gates or fences down or damaged.
- Power lines down or damaged.

2. After arriving at the scene, observe:

- Tire or footprint impressions leading to the fire origin.
- Suspicious-looking people (sometimes trying to help).
- Conversations of on-lookers (who, what, where, when, and how).
- Power lines down (also a hazardous condition for firefighters).
- General area of origin, what is burning, color of smoke, where burning, etc.

- Any objects that are foreign to the natural or normal surroundings.
 - Signs of a campfire or debris burning.
3. During initial attack, note and immediately report any ignition devices observed in the area of origin, such as:
- Matchbooks
 - Candles
 - Road flares/fusees

B. Record

C. Report

D. Protect

1. Don't:

- Walk through the suspected origin area.
- Apply water or cut a fireline through the area.
- Drive vehicles over the origin area.

2. Do:

- Use flagging tape, rope, or rolled toilet paper to protect a larger area.

- Keep others away from the suspected area by posting guards, if necessary.
- Protect origin by placing hand tools around a suspected small area.

III. APPLICATION

IV. EVALUATION

FIREFIGHTER TRAINING, S-130

Unit 18 - Cultural Resources (Optional)

OBJECTIVES: Upon completion of this unit, students will be able to:

1. Define the phrase “Cultural Resources.”
2. Describe the effects of fire and fire management activities on cultural resources.
3. Describe the steps to protect cultural resources during fire management activities.

- I. INTRODUCTION

- II. CULTURAL RESOURCES - DEFINITIONS AND TERMINOLOGY
 - A. Cultural Resource

 - B. Types of Archaeological/Cultural Resources
 - 1. Artifact
 - 2. Feature
 - 3. Site
 - 4. Context

- III. HISTORICAL OVERVIEW

- IV. LEGAL RESPONSIBILITIES
 - A. National Historic Preservation Act (NHPA) of 1966

 - B. Archaeological Resources Protection Act (ARPA) of 1979

- V. EFFECTS OF FIRE MANAGEMENT ACTIVITIES ON CULTURAL RESOURCES
 - A. Positive impacts from fire and fire suppression activities:

1. Identifying previously unknown artifacts/sites.
 2. Reduce vegetation so areas can be surveyed.
- B. The most severe impacts to cultural resources occur during fire suppression and rehabilitation activities.
- C. Impacts from Fire Suppression
1. Fireline construction with mechanical equipment.
 2. Handline and helispot construction:
 3. Aerial applications
 4. Concentration of people in and around sites.
 5. Stockpiling and collecting of artifacts by fire suppression personnel. DON'T DO IT!
- D. Impacts from Mopup Activities
1. Engines and other vehicles moving around inside the burned area crushing or displacing cultural materials.
 2. Dragging hoses across sites and material which can cause breakage, artifact displacement, or structural damage to features such as burials, pithouses and hearths.
 3. Digging and tillage of the soil, straight stream water application, digging roots and stump holes

- E. Impacts from Prescribed Fire
 - 1. The impact of installing control lines.
 - 2. The actual physical impact of fire on structures, pottery, and stone artifacts, and archaeological sites.
 - 3. The loss of ground cover can lead to erosion and vandalism. Positive impacts are the same as described for fire suppression.

VI. STEPS TO PROTECT CULTURAL RESOURCES DURING WILDFIRE SUPPRESSION AND PRESCRIBED BURNING ACTIVITIES

- A. Be Aware
- B. Avoid Significant or Unknown Eligibility Sites
- C. Report